



THREE WARMER POUROVER BREWERS

Project Date Models CPO-3P-15A, CPO-3RP-15A Item# Quantity



model CPO-3P-15A



model CPO-3RP-15A

Features

- Solid and dependable, meet the CPO portable three warmer pourover brewers.
- Stand-alone, temperature-controlled powerhouses brew directly into decanters.
- Two additional warmers to keep extra decanters of coffee ready to be served.
- All stainless steel construction.
- Completely portable unit.
- Requires no plumbing.
- 1.2 gallon (4.5 L) tank capacity.

Models & Dimensions

Three Warmer Pourover Brewers

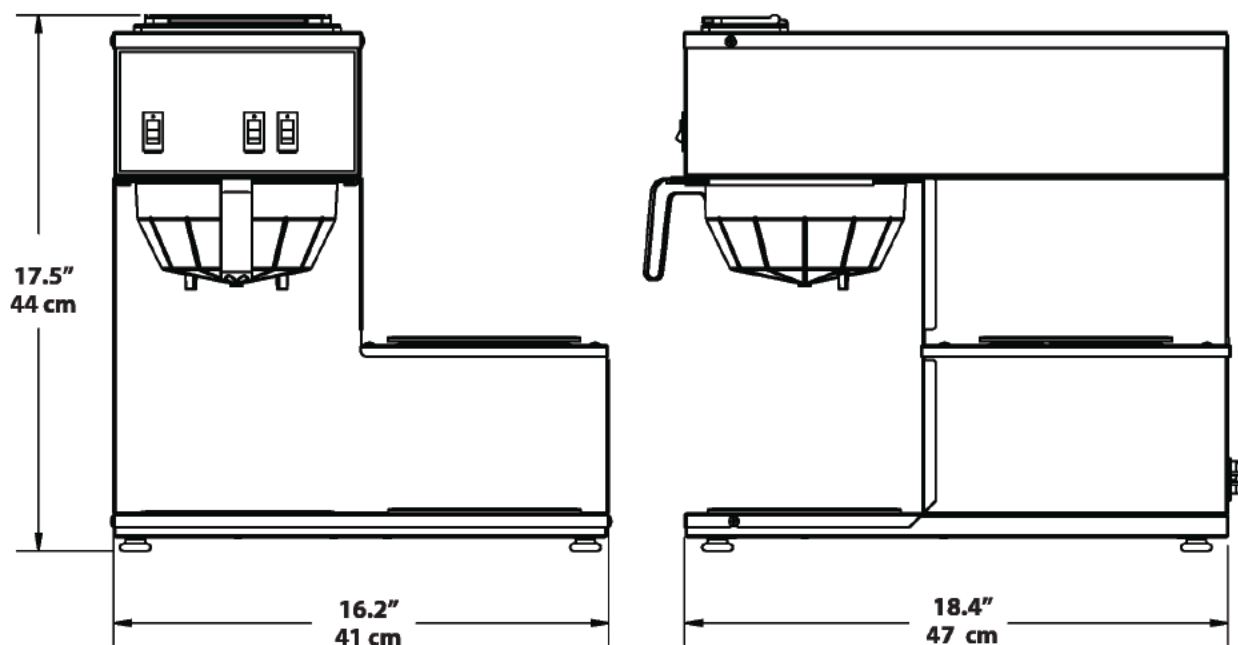

model CPO-3RP-15A represented

Specifications

Model	Description	Electrical	Product Dimensions (H x W x D)	Ship Dimensions (H x W x D)	Ship Weight
CPO-3P-15A (0002-30001)	Warmers: 3 total: 2 top and 1 bottom.	120V / 15A 1700 W / 1 Ph	18.5" x 8.1" x 18.4" (47 cm x 21 cm x 47 cm)	20.75" x 12" x 23.5" (53 cm x 30 cm x 60 cm)	30 lbs. (13.6 kg)
CPO-3RP-15A (0002-30005)	Warmers: 3 total: 1 right top, 1 bottom, 1 right bottom.	120V / 15A 1700 W / 1 Ph	17.5" x 16.2" x 18.4" (44 cm x 41 cm x 47 cm)	22" x 20" x 23.5" (56 cm x 51 cm x 60 cm)	35 lbs. (15.9 kg)

Note: Decanters sold separately. Accessories available separately.

Electrical: NEMA 5-15P or 5-20P line cord included.

