





Project Name:	
Location:	
Item:	Qty:
Model:	



BRG-R23 / BRG-F23 / BRG-R49 / BRG-R49 / BRG-R72 / BRG-R72

REACH-IN REFRIGERATION





BRG-R23 
 BRG-F23 



BRG-R49 
 BRG-F49 



BRG-R72 
 BRG-F72 



Doors are reversible
 (additional parts required)

FEATURES

Berg reach-in refrigeration is built to last. Temperature is digitally controlled and easily viewed from the exterior of the cabinet. Stainless steel construction ensures years of long life and maximum durability. Berg units are designed to meet the requirements of the most discriminating customer.

- Stainless steel exterior and interior ensures years of long life and maximum durability
- CFC-free polyurethane foam insulation
- 3 heavy-duty, adjustable, PE coated wire shelves per section
- Door locks and 4" diameter swivel casters come standard

- Utilizes environmentally friendly CFC-free refrigerant, Refrigerators: R134A / Freezers: R404A*
 *Except Single Door Freezer BRG-F23 which uses R134A
- Automatic defrost system
- Digitally controlled temperature system maintains optimum temperature and LED display is easily viewed from exterior
- Holding temperature:
 Refrigerator: 33°F to 39°F, Freezer: 5°F to -9°F
- Open door alert, beeps when door has been open for 3 minutes
- Large evaporator and condenser for quick cooling and greater efficiency
- Automatic interior lighting
- Self contained system
- Recessed handles
- Standard electrical: 120V/60Hz with NEMA 5-15, except BRG-F72 3-door freezer which is 230V/60Hz with L14-20 cord

 NSF 7  UL471  DOE 2017 Compliant	Specifications subject to change without notice.
	Approvals: ETL, ETL Sanitation approved

BRG-R23 / BRG-F23 / BRG-R49 / BRG-R49 / BRG-R72 / BRG-R72



BRG-R23 / BRG-F23 / BRG-R49 / BRG-F49 / BRG-R72 / BRG-F72

REACH-IN REFRIGERATION

DIMENSIONS

BRG-R23
BRG-F23

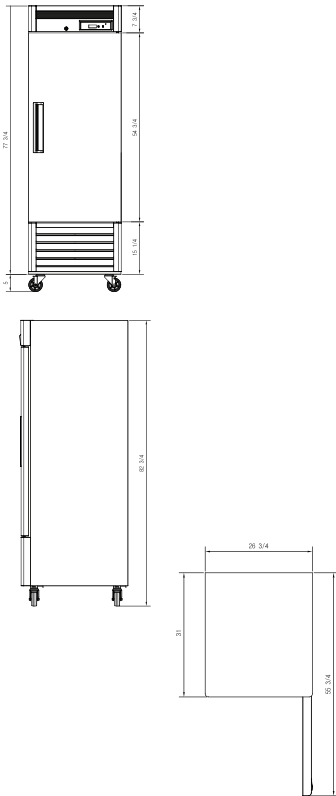

BRG-R49
BRG-F49

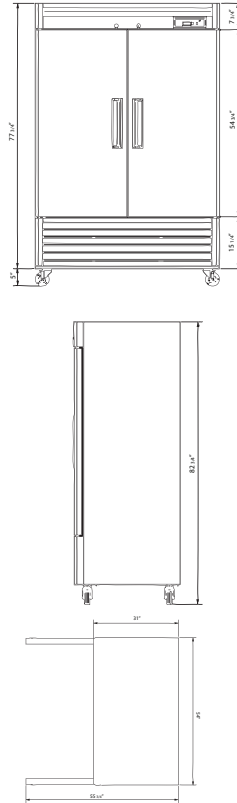

BRG-R72
BRG-F72

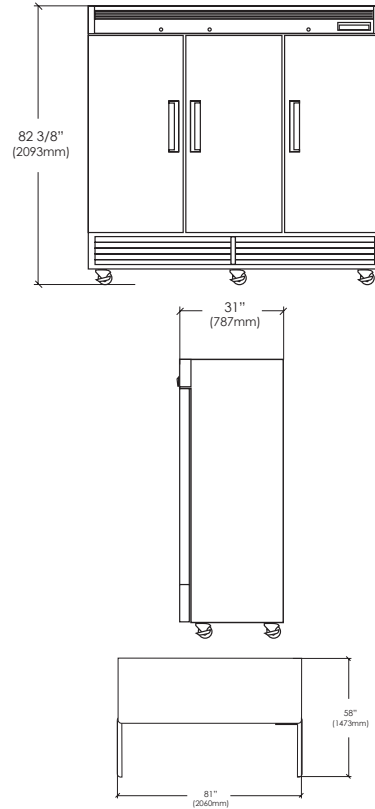

Model	Dim (W"xD"xH")	Nominal Capacity	Temp	Watts	Doors	Weight	Shelves
BRG-R23 Refrigerator	26.75 x 31 x 82.75 680x787.4x2102mm	23 Cu Ft 651 L	33° to 39°F -2° to 4°C	690	1	271 lb 123 kg	3
BRG-F23 Freezer	26.75 x 31 x 82.75 680x787.4x2102mm	23 Cu Ft 651 L	-9° to 5° F -23° to -15° C	805	1	284 lb 129 kg	3
BRG-R49 Refrigerator	54 x 31 x 82.75 1372x787.4x2102mm	49 Cu Ft 1,387 L	33° to 39°F -2° to 4°C	805	2	397 lb 180 kg	6
BRG-F49 Freezer	54 x 31 x 82.75 1372x787.4x2102mm	49 Cu Ft 1,387 L	-9° to 5° F -23° to -15° C	1254	2	403 lb 183 kg	6
BRG-R72 Refrigerator	81 x 31 x 82.75 2057.4x787x2102mm	72 Cu Ft 2048 L	33° to 39°F -2° to 4°C	1185	3	634 lb 287 kg	9
BRG-F72 Freezer	81 x 31 x 82.75 2057.4x787x2102mm	72 Cu Ft 2048 L	-9° to 5° F -23° to -15° C	1060/ 545*	3	650 lb 295kg	9

* Requires NEMA L14-20P plug