

Operating Instructions

Commercial Microwave Ovens

Models No.

**NE-12521 / NE-12523 / NE-17521 / NE-17523 /
NE-17723 / NE-21521 / NE-21523**

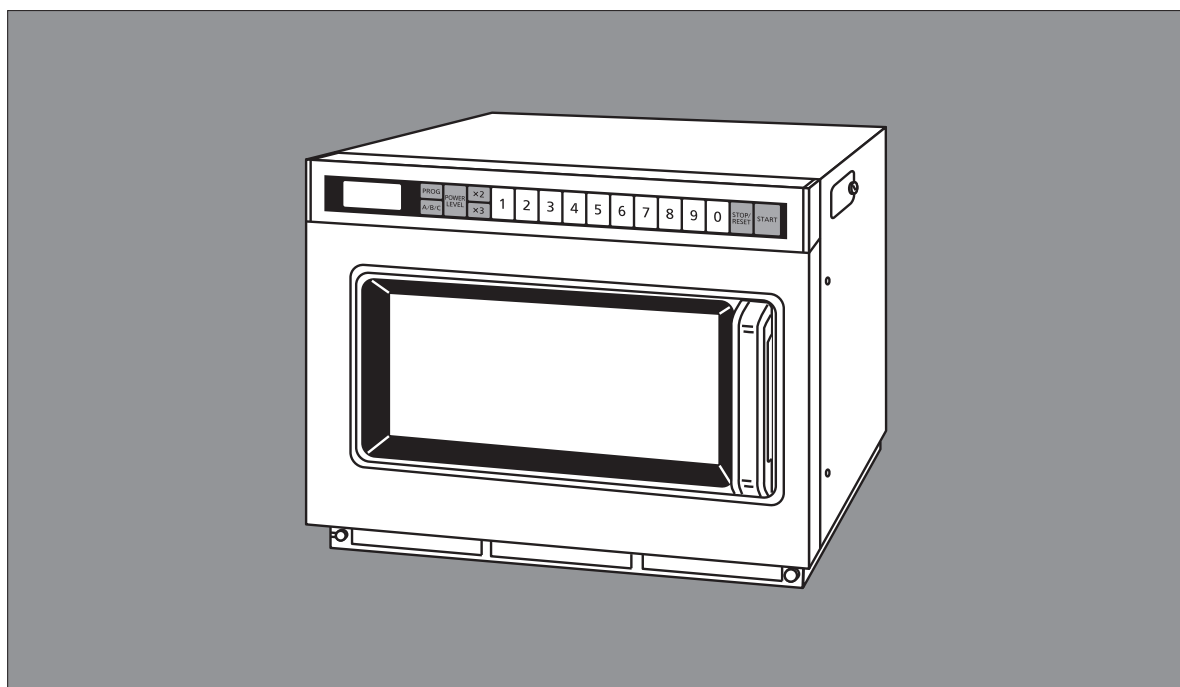

*Model No. NE-17723

Please read these instructions carefully before using this product and save this manual for future use.

Before Calling for Service:

If failure code “F□□” appears in the display, unplug oven and wait for 5 seconds before reconnecting. If normal operation does not resume, call the service agent with the information of failure code.

Contents

PRECAUTIONS TO AVOID POSSIBLE EXPOSURE TO EXCESSIVE MICROWAVE ENERGY	3
IMPORTANT SAFETY INSTRUCTIONS	3
Installation and GROUNDING INSTRUCTIONS	4
Caution	4
ATTENTION	5
Self Diagnostics Failure Code Explanation	6
If a “U” Appears In The Display	6
Power Source Voltage Adjustment	7
How Does The Microwave Work?	7
Outline Diagram	8
SD Memory Card	9
How to Operate	
POWER LEVEL SELECTOR PAD	10
A. MANUAL HEATING . . . single stage heating	10
. 2 to 5 stage heating	11
B. PROGRAMMED HEATING	12
C. PROGRAMMING NUMBER/MEMORY PADS . . . single stage heating	12
. 2 to 5 stage heating	13
D. PROGRAMMING DOUBLE OR TRIPLE QUANTITY PAD	14
E. PROGRAM LOCK	14
F. BEEP TONE	15
G. PROGRAM LIST	17
H. CYCLE COUNTER	18
I. AIR FILTER CLEANING	18
J. OVEN LAMP	19
Installation Instructions for Stacking	21
Sanitary Counter Top Seal	21
Care of Your Oven	22
Cleaning and Maintenance procedures	23
Heating and Defrosting Time Charts	24
PANASONIC COMMERCIAL MICROWAVE OVEN WARRANTY	38
Technical Specifications	40

Owner's Record

Model No. _____

Serial No. _____

The serial number of this products
may be found on the side of the oven.

Date of Purchase _____

Dealer's Name _____

Dealer's Address _____

See page 6 before calling

Toll Free Service Information

To locate a convenient service agent call

1-888-350-9590

Chef Support: 201-348-7305

www.panasonic.com/cmo

Virtual Test Kitchens

PRECAUTIONS TO AVOID POSSIBLE EXPOSURE TO EXCESSIVE MICROWAVE ENERGY

- (a) **Do not attempt to operate this oven with the door open** since open-door operation can result in harmful exposure to microwave energy. It is important not to defeat or tamper with the safety interlocks. Under normal conditions, the oven will not operate with the door open.
- (b) **Do not place any object** between the oven front face and the door, or allow soil or cleaner residue to accumulate on sealing surfaces.
- (c) **Do not operate the oven** if it is damaged. It is particularly important that the oven door close properly and that there is no damage to the :
 - (1) door (bent)
 - (2) hinges and latches (broken or loose)
 - (3) door seals and sealing surfaces.
- (d) **The oven should not be adjusted or repaired** by anyone except properly qualified service personnel.

IMPORTANT SAFETY INSTRUCTIONS

Your microwave oven is a cooking device and you should use as much care as you use with a stove or any other cooking device.

When using this electric appliance, basic safety precautions should be followed, including the following:

WARNING—To reduce the risk of burns, electric shock, fire, injury to persons or exposure to excessive microwave energy:

1. Read all instructions before using the appliance.
2. Read and follow “**PRECAUTIONS TO AVOID POSSIBLE EXPOSURE TO EXCESSIVE MICROWAVE ENERGY,**” found above.
3. This appliance must be grounded. Connect only to a properly grounded outlet. See “**Grounding Instructions**” found on page 4.
4. Install or locate this appliance only in accordance with the provided installation instructions found on page 4.
5. Do not cover or block any openings on this appliance.
6. Do not store or use this appliance outdoors. Do not use this product near water for example, near a kitchen sink, in a wet basement, or near a swimming pool, and the like.
7. Use this appliance only for its intended use as described in this manual. Do not use corrosive chemicals or vapors in this appliance. This type of oven is specifically designed to heat, or cook food. It is not designed for industrial or laboratory use.
8. When cleaning surfaces of door and oven that come together on closing the door, use only mild, non-abrasive soaps or detergents applied with a sponge or soft cloth.
9. As with any appliance, close supervision is necessary when used by children.
10. Do not operate this appliance if it has a damaged cord or plug, if it is not working properly, or if it has been damaged or dropped.
11. Do not immerse cord or plug in water.
12. Keep cord away from heated surfaces.
13. Do not let cord hang over edge of table or counter.
14. This appliance should be serviced only by qualified service personnel. Contact the nearest authorized service facility for examination, repair or adjustment.
15. Some products such as whole eggs and sealed containers (for example, closed glass jars) may explode and should not be heated in this oven.
16. To reduce the risk of fire in the oven cavity:
 - (a) Do not overcook food. Carefully attend appliance if paper, plastic, or other combustible materials are placed inside the oven to facilitate cooking.
 - (b) Remove wire twist-ties from paper or plastic bags before placing bag in oven.
 - (c) If materials inside the oven should ignite, keep oven door closed, turn oven off, and disconnect the power cord, or shut off power at the fuse or circuit breaker panel.
 - (d) Do not use the cavity for storage purposes. Do not leave paper products, cooking utensils, or food in the cavity when not in use.
17. Liquids, such as water, coffee, or tea are able to be overheated beyond the boiling point without appearing to be boiling due to surface tension of the liquid. Visible bubbling or boiling when the container is removed from the microwave oven is not always present. **THIS COULD RESULT IN VERY HOT LIQUIDS SUDDENLY BOILING OVER WHEN A SPOON OR OTHER UTENSIL IS INSERTED INTO THE LIQUID.** To reduce the risk of injury to persons:
 - (a) Do not overheat the liquid.
 - (b) Stir the liquid both before and halfway through heating it.
 - (c) Do not use straight-sided containers with narrow necks.
 - (d) After heating, allow the container to stand in the microwave oven for a short time before removing the container.
 - (e) Use extreme care when inserting a spoon or other utensil into the container.

SAVE THESE INSTRUCTIONS

For proper use of your oven read remaining safety cautions and operating instructions.

Installation and GROUNDING INSTRUCTIONS

Placement of the Oven

Locate the oven on a smooth, flat and stable surface. There should be no gap between the table surface and the bottom of the oven. Do not place the oven in a hot or damp area, ie. near a stove, sink or directly above heat lamps on a serving line. Free airflow around the oven is important. There is a possibility of a small amount of interference with weak broadcast signals if the microwave oven is too close to a radio or TV.

Grounding Instructions

This oven must be grounded electrically. In the event of an electrical short circuit, grounding reduces the risk of electric shock by providing an escape wire for the electric current. The appliance is equipped with a cord having a grounding wire with a grounding plug. The plug must be plugged into an outlet that is properly installed and grounded.

WARNING — improper use of the grounding plug can result in a risk of electric shock.

Consult a qualified electrician or service person if the grounding instructions are not completely understood, or if doubt exists as to whether the appliance is properly connected.

If it is necessary to use an extension cord, use only a three wire extension cord that has a three blade grounding plug, and a three slot receptacle that will accept the plug on the appliance. The marked rating of the extension cord should be equal to or greater than the electrical rating of the oven.

Protective Film Removal

A blue protective film is used to prevent scratching of the outer case during transportation. Peel the film from the exterior of the oven before installation or use.

Wiring Requirements

No other appliance should share the circuit with the microwave oven. If it does, the branch circuit fuse may overload and either cause the oven to heat slower than expected or blow the fuse.

A. For Models No. NE-12521/NE-12523

The oven must be on a SEPARATE, 20 amp, 60 Hz-120 V GROUNDED CIRCUIT.

NEMA#
5-20P

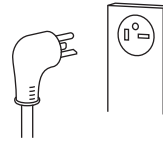

120 V
Grounded
Outlet
NEMA# 5-20R

B. For Models No. NE-17521/NE-17523/NE-17723/ NE-21521/NE-21523

1. This oven must be on a separate, 60 Hz GROUNDED CIRCUIT - minimum 15 amps for Models No. NE-17521/NE-17523/NE-17723; minimum 20 amps for Models No. NE-21521/NE-21523.
2. The microwave ovens are built to operate on 2 different voltages (230-240 V or 208 V).

Models No.
NE-17521/NE-17523/
NE-17723

NEMA#
6-15P

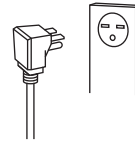

208 V/230-240 V
Grounded Outlet
NEMA# 6-15R or 6-20R

Models No.
NE-21521/NE-21523

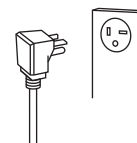

NEMA#
6-20P

208 V/230-240 V
Grounded Outlet
NEMA# 6-20R

Caution

1. Do not attempt to tamper with or make any adjustments or repairs to the door, control panel housing, safety interlock switches or any other part of the oven. Do NOT remove the outer panel of the oven. Repairs should only be done by a qualified service person.
2. Do NOT operate the oven empty. The microwave energy will reflect continuously throughout the oven if no food or water is present to absorb energy.
3. If a fire occurs in the oven, press the Stop/Reset pad and LEAVE THE DOOR CLOSED. Disconnect the power cord, or shut off the power at the fuse or circuit breaker panel.
4. Do NOT attempt to dry clothes, newspapers or other materials in the oven, as they may catch on fire.
5. Do NOT use recycled paper products, as they may contain impurities which may cause sparks and/or fires.
6. Do NOT use newspapers or paper bags for cooking.
7. Do NOT hit or strike the control panel. Damage to controls may occur.
8. POT HOLDERS may be needed when removing food from the oven. Heat is transferred from the hot food to the container.
9. Do NOT store flammable materials next to, on top of, or in the oven. It could be a fire hazard.
10. Do NOT operate the oven without the spatter shields (located in the top of inner cavity) in place.

ATTENTION

PLEASE READ THE FOLLOWING CAUTIONS BEFORE USING THIS MICROWAVE OVEN

Failure to follow these instructions and properly maintain this unit may lead to premature failure of the Microwave and may void the warranty.

Please read the following guidelines along with the included owner's manual prior to operating this unit.

- Unit must be placed in an open area, making certain that there is adequate clearance and ventilation in the back and front of the unit.
- Filters must be cleaned and re-installed on a regular schedule in order to provide proper air flow through out the unit. Failure to properly maintain the filters will result in the Microwave overheating and possible early component failure.
- Top Splatter shield **MUST** be installed at all times when unit is in operation. Failure to install the splatter shield will result in food buildup on the inside top of the cavity and will eventually lead to arcing and the eventual destruction of the cavity and will void the warranty.
- Do not scrap or peel off rubber gasket around the base of the bottom plate as this will allow spillage under the bottom plate and may lead to destruction of the cavity.
- Do not slam door shut or pull down of the door as this may damage the door latch mechanism and / or hinges and render the Microwave inoperative.
- Do not over fill pans as spillage may occur. If spillage does occur, please wipe it up immediately. Follow the guides on the back of this placard for proper cleaning instructions.
- Do not place unit near other sources of heat, such as stoves, heat lamps, or ovens as this may shorten the life of the Microwave oven components and render the unit inoperative.
- Do not place metal objects such as aluminum foil, metal pans or metal utensils as this will damage both the inside of the cavity as well as electronic components.

IF BOTTOM PLATE BREAKS or CRACKS, or THERE IS SPARKING IN THE CAVITY WHILE HEATING FOOD, DO NOT CONTINUE TO USE OVEN CONTACT AUTHORIZED SERVICE AGENCY IMMEDIATELY!! 1-888-350-9590

Self Diagnostics Failure Code Explanation

This oven monitors its operation and displays a Failure Code in Digital Display Window when a problem occurs.

What to do when a Failure Code appears:

When "F□□" is displayed, remove the plug, wait 5 seconds, and reinsert.

If "F" is displayed again, call the service agent.

Note: Not all codes displayed in the Digital Display Window indicate a failure.

If a "U" Appears In The Display

A fault will also show as a Failure Code in the display window (it will appear as a "U" then a two digit number).

Follow the steps in the following chart:

CODE	PROBLEM	WHAT TO DO
U16	Cannot write because the SD Memory Card is locked. *SD Memory Card information can be read.	Remove the SD Memory Card and check whether it is locked. Replace the SD Memory Card when finished. <div style="text-align: center;">  </div>
U17	An SD Memory Card other than the card provided is in use.	Use the provided SD Memory Card.
U19	SD Memory Card is not inserted.	Remove the SD Memory Card Cover and insert an SD Memory Card.
U30	Memory cooking has exceeded the maximum time during Double Quantity and Triple Quantity settings.	Check and change the time.

Power Source Voltage Adjustment

Models No. NE-17521/NE-17523/NE-17723/NE-21521/NE-21523

The microwave automatically detects 208 V and 230 V–240 V. Insert the plug, and if the Digital Display Window goes blank 10 seconds after use, unplug and insert the plug again.

How Does The Microwave Work?

Microwaves are a form of high frequency radio waves similar to those used by a radio including AM, FM, and CB. They are, however, much shorter than radio waves; approximately five inches long. Electricity is converted into microwave energy by the magnetron tube. From the magnetron tube, microwave energy is transmitted to the oven cavity where it is: reflected, transmitted and absorbed.

Reflection

Microwave are reflected by metal just as a ball is bounced off a wall. A combination of stationary (interior walls) and rotating antenna, located underneath the bottom shelf and above the ceiling cover assure that the microwaves are well distributed within the oven cavity to produce even heating or cooking of foods.

Transmission

Microwave pass through some materials such as paper, glass and plastic much like sunlight shining through a window. Because these substances do not absorb or reflect the microwave energy, they are ideal materials for microwave oven heating containers when covered.

Absorption

During heating, microwaves will be absorbed by food. They penetrate to a depth of about $\frac{3}{4}$ to $1\frac{1}{2}$ inches. Microwave energy excites the molecules in the food (especially water, fat and sugar molecules), and causes them to vibrate at a rate of 2,450,000,000 times per second. This vibration causes friction, and heat is produced just as you will feel heat produced if you vigorously rub your hands together. The internal heating of larger foods is done by conduction. The heat which is produced by friction is conducted to the center of the food. Foods also continue to heat by conduction during standing time. ("carry-over" cooking) Because microwaves dissipate, much like sunlight as it reaches the Earth's surface, they are not stored in food.

Radio Interference

1. Operation of the microwave oven may cause interference to your radio, TV or similar equipment.
2. When there is interference, it may be reduced or eliminated by taking the following measures:
 - a. Clean door and sealing surfaces of the oven. (See Care of Your Microwave Oven found on page 22.)
 - b. Place the radio, TV, etc. away from the microwave oven as far as possible.
 - c. Use a properly installed antenna, to obtain stronger signal reception.

Outline Diagram

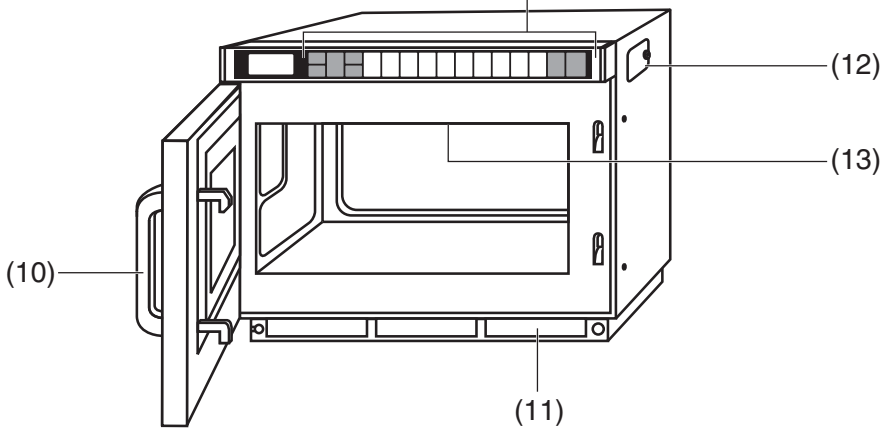
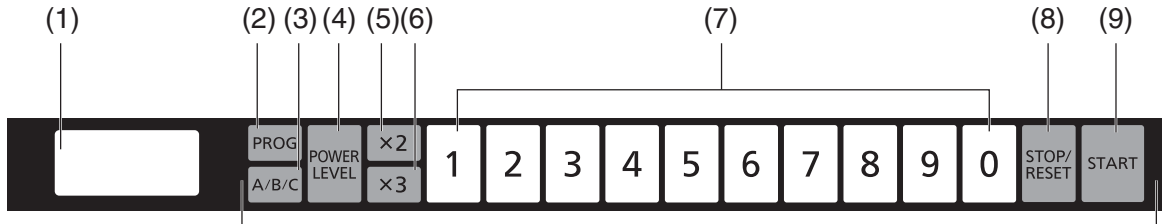

- (1) Digital Display Window (see below)
- (2) Program pad
- (3) Shift (A/B/C) pad
- (4) Power Level Selector pad
- (5) Double Quantity pad
- (6) Triple Quantity pad
- (7) • Number/Memory pads
- Time input

- (8) Stop/Reset pad
- (9) Start pad
- (10) Door Handle
- (11) Air Filter
- (12) SD Memory Card Cover*
- (13) Splatter Shield (top of inner cavity)

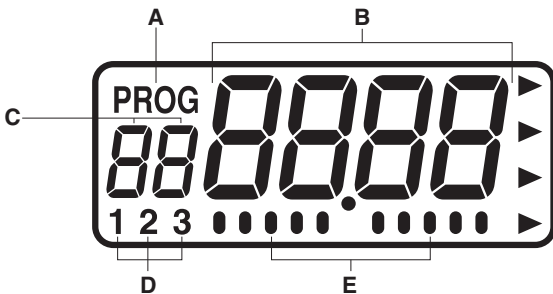

- A – Program Display
- B – Heating Time Display (min. sec. hour)
- C – • Memory pad Number Display
- Heating Stage Indicator
- D – Pattern of buzzer sound settings
- E – • Calling Programmed Heating: Stage Number Indicator
- Programmed Heating in Progress: Operation Indicator
- Beep tone settings: Scale Indicator

This oven is preset at the factory as follows:

- ◆ Number/Memory pads preset HIGH power at the indicated heating times for single stage heating (See pages 10-13)

1 = 10 sec.	2 = 20 sec.	3 = 30 sec.	4 = 40 sec.	5 = 50 sec.
6 = 1 min.	7 = 1 min. 15 sec.	8 = 1 min. 30 sec.	9 = 1 min. 45 sec.	0 = 2 min.
 - Model No. NE-17723: Memory numbers are displayed using 1 digit for 1 to 9, 2 digits for 10 to 99, and 3 digits for 000 to 999. There are three sides, A (00 to 99), B (00 to 99) and C (00 to 99).
 - Other models: There are three sides, A, B and C. Only A-side is preset.
 - ◆ Program Unlocked (See pages 14-15)
 - ◆ Double Quantity = 1.6 Triple Quantity = 2.2 (See page 14)
 - ◆ Oven Lamp When the door is open = ON Blinking at the end of heating cycle = OFF
Decrease brightness during cooking = OFF (See pages 19-20)
 - ◆ The default filter cleaning time is set to "0".
- If you wish to change these settings, please consult the operating instructions for programming procedure. (See page 18)

*In this manual, illustrations of Model No. NE-17723 is used for explanation purposes. Model numbers other than NE-17723 do not have SD Memory Card functions.

SD Memory Card

*Model No. NE-17723 only (An SD Memory Card is included in the unit purchased.)

- An SD Memory Card is included in the unit purchased. It allows you to store up to 1300 Memory Programmes in the oven.
- Use the card when storing or recalling Memory Programmes.

How to insert / remove the SD Memory Card

*Before you insert / remove an SD Memory Card, always disconnect the oven from the power supply. If this is not possible, the display window should be blank, otherwise, the data on the SD Memory Card may be damaged.

How to remove

1. Use a coin or tool to remove the screw from the SD Memory Card Cover.

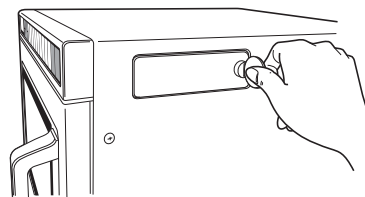

2. Push the SD Memory Card with your finger to draw it out. Then, remove it.

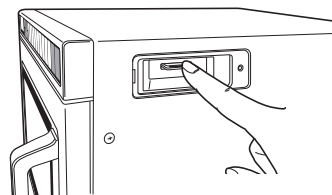

How to insert

1. Insert an SD Memory Card with its label facing up as indicated by ▲ mark until it snaps into place.

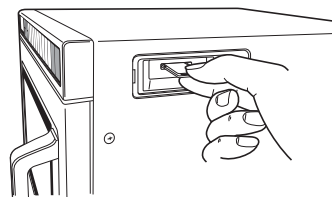

2. Fit the left edge of the SD Memory Card Cover. Screw to close at the right-hand side.

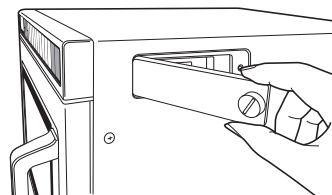

Caution:

1. Always close the SD Memory Card Cover except when an SD Memory Card is inserted/removed in order to prevent water or dust from entering.
2. Insert only an SD Memory Card specified for this oven. Do not use any other type or substitute SD Memory Card.
3. Keep the removed SD Memory Card away from static electricity.
4. Do not disassemble or modify SD Memory Cards.
5. Do not apply a physical shock to SD Memory Cards. Do not bend, drop, or get them wet.
6. Do not touch the metal terminals of an SD Memory Card with your hand or metal.
7. Do not remove the label. Do not paste another label onto the SD Memory Card.
8. Do not leave SD Memory Cards in locations subject to high temperatures or direct sunlight and corrosive gases.
9. If the SD Memory Card is lost or becomes faulty, please contact a Service Engineer to obtain a replacement.

How to Operate

POWER LEVEL SELECTOR PAD

Each time the pad is pressed, the Power Level switches as the illustration below.



HIGH	P10: Models No. NE-12521 / NE-12523 (1200 W), NE-17521 / NE-17523 / NE-17723 (1700 W), NE-21521 / NE-21523 (2100 W)				
MEDIUM HIGH	P9: 95 %	LOW	P3: 35 %	HEAT FROM TOP DOWN	PU1: 50 %
	P8: 85 %		P2: 25 %*		PU2: 25 %
MEDIUM	P7: 75 %	DEFROST	P1: 340 W	HEAT FROM BOTTOM UP	PL1: 50 %
	P6: 65 %		P0: 0 %		PL2: 25 %
	P5: 55 %	—			
	P4: 45 %				

*: "LOW (P2)" for Model No. NE-12521 / NE-12523 is 30%.

A. MANUAL HEATING — single stage heating —











Example: To cook food at HIGH power for 2 minutes

	PAD	INSTRUCTION	DIGITAL DISPLAY WINDOW
1		Place food inside the oven and close the door. ☛ The oven lamp will turn on and "0" will appear. Note: While "0" appears, operation is available. 1 minute after the door is closed, "0" will disappear.	
2		Press Power Level Selector pad once. ☛ The selected power level will be indicated and 1st Stage Heating Indicator "1" will start to blink. Note: Each time the pad is pressed, the Power Level switches as the above Power Level Selector pad illustration.	
3		Press Number/Memory pads "2", "0" and "0". ☛ The set heating time will appear. Note: The maximum set time for "DEFROST" and "P0" is 30 minutes, and 15 minutes for all others.	
4		Press Start pad. ☛ The oven lamp will turn on and heating will start. During operation, the indicator appears from the left and heating time will count down.	
<ul style="list-style-type: none"> When all time expires, beep tone will sound and heating will stop. The oven lamp will turn off. "0000" will blink until the door is opened. 1 minute later, cooling fan will stop. Open the door and take the food out. The oven lamp will turn on. Digital Display Window will show the originally selected time and power stage. Close the door. The oven lamp will turn off. 1 minute later, Digital Display Window will go blank. 			

How to Operate

A. MANUAL HEATING — 2 to 5 stage heating —

Example: To cook food at HIGH power for 2 minutes and at DEFROST power for 1 minute

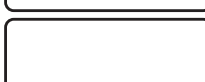
	PAD	INSTRUCTION	DIGITAL DISPLAY WINDOW
		Follow steps 1 to 3 on page 10.	
4		Press Power Level Selector pad. <ul style="list-style-type: none"> Each time the pad is pressed, the Power Level switches as the Power Level Selector pad illustration on page 10. The selected power level will be indicated and 2nd Stage Heating Indicator “2” will start to blink. 	
5		Press Number/Memory pads “1”, “0” and “0”. <ul style="list-style-type: none"> The set heating time will appear. Note: The maximum set time for “DEFROST” and “P0” is 30 minutes, and 15 minutes for all others. However, the TOTAL TIME can be set up to 25 minutes for continuous heating (2 to 5 stage heating) that excludes “DEFROST” and “P0”.	
6		Press Start pad. <ul style="list-style-type: none"> The oven lamp will turn on. The total time is displayed. During operation, the indicator appears in order from the left and heating time for the first stage will count down. 	 
<ul style="list-style-type: none"> After the first stage heating, beep tone will sound. The Heating Stage Indicator “2” are displayed and heating time will count down. When all time expires, beep tone will sound and heating will stop. The oven lamp will turn off. “0000” will blink until the door is opened. 1 minute later, cooling fan will stop. Open the door and take the food out. The oven lamp will turn on. Digital Display Window will show the originally set time and Heating Stage Number. Close the door. The oven lamp will turn off. 1 minute later, Digital Display Window will go blank. 			   

Note: Repeat the above procedure to set Heating for the third stage and later stages.

SPECIAL NOTE: For both single and 4 stage heating

- While heating, one press on Stop/Reset pad stops the operation. You can restart it by pressing Start pad or a second press on Stop/Reset pad will cancel the selected program.
- While not heating, one press on Stop/Reset pad cancels the selected program.
- When heating is complete, you can repeat exactly the same manually selected heating time by pressing only Start pad you use the oven again within 1 minute.
- 1 minute later of non-use with door closed, the repeat feature will be cancelled.

How to Operate

PROGRAM MEMORY

Model No. NE-17723 (1300 memory): 1 digit input = 0 to 9, 2 digit input = 00 to 99, 3 digit input = 000 to 999 and A00 to C99
 Other models (30 memory): A0 to C9 *For A settings, you do not need to press Shift (A/B/C) pad.

To change the number of memory digits:









1. Press "Start" + "0" while the door is open.
2. Press the number of digits you want to set. (1 digit=1, 2 digits=2, 3 digits=3)
3. Press "Prog".

Note: The Digital Display Window illustration here is Model No. NE-17723.
 The Digital Display Window differs for other models.

B. PROGRAMMED HEATING

◆ In Program Unlock Mode:

Example: To select Number/Memory pads "1" and "3" at A side in which your desired heating program (at HIGH power for 3 min., single stage heating) is set

PAD	INSTRUCTION	DIGITAL DISPLAY WINDOW
1	Place food inside the oven and close the door. ☛ The oven lamp will turn on and "0" will appear. Note: While "0" appears, operation is available. 1 minute after the door is closed, "0" will disappear.	
2   	Press Shift (A/B/C) pad, the desired Number/Memory pads "1" and "3". ☛ The currently programmed information will be indicated. Note: All models except Model No. NE-1772 display the memory number and time.	 
3 	Press Start pad. ☛ The oven lamp will turn on and heating will start. The heating time will count down.	
<ul style="list-style-type: none"> • When all time expires, beep tone will sound and heating will stop. The oven lamp will turn off. "0000" will blink until the door is opened. 1 minute later, cooling fan will stop. • Open the door and take the food out. The oven lamp will turn on. • Close the door. The oven lamp will turn off. 1 minute later, Digital Display Window will go blank. 		 

◆ In Program Lock Mode:

Just press the desired Number/Memory pad. Heating will automatically start without pressing Start pad.



✎ For Double (or Triple) Quantity heating:

Press Double (or Triple) Quantity pad before pressing the desired Number/Memory pad.









C. PROGRAMMING NUMBER/MEMORY PADS — single stage heating —

THE OVEN CAN NOT BE PROGRAMMED WHEN PROGRAM LOCK IS ACTIVATED! (See pages 14-15)

Example: To program cooking at DEFROST power for 1 minute into Number/Memory pads "1" and "5" at A side

PAD	INSTRUCTION	DIGITAL DISPLAY WINDOW
1	Open the door and leave it open. ☛ The oven lamp will turn on, and "0" will appear.	
2 	Press Prog pad. ☛ "PROG" will start to blink.	

How to Operate

	PAD	INSTRUCTION	DIGITAL DISPLAY WINDOW
3	 1 5	Press Shift (A/B/C) pad, Number/Memory pads “1” and “5”. <ul style="list-style-type: none"> The selected pad number will appear and currently programmed information will be indicated. 	
4		Press Power Level Selector pad. <ul style="list-style-type: none"> Each time the pad is pressed, the Power Level switches as in the Power Level Selector pad illustration on page 10. The selected power level will be indicated, 1st Stage Heating Indicator “1” will start to blink. 	
5	1 0 0	Press Number/Memory pads “1”, “0” and “0”. <ul style="list-style-type: none"> The set heating time will appear. Note: The maximum set time for “DEFROST” and “P0” is 30 minutes, and 15 minutes for all others.	
6		Press Prog pad. <ul style="list-style-type: none"> “PROG” and 1st Stage Heating Indicator “1” will stop blinking. This means that you have completed programming. 	
		<ul style="list-style-type: none"> 3 seconds later, “0” will appear. 	







Note:

- Program the remaining Number/Memory pads as desired by repeating steps 1-6 above.
- When “PROG” is blinking in Digital Display Window, the program can be cancelled and/or one press on Stop/Reset pad erases the programmed Number/Memory pad number.

C. PROGRAMMING NUMBER/MEMORY PADS — 2 to 5 stage heating —

THE OVEN CAN NOT BE PROGRAMMED WHEN PROGRAM LOCK IS ACTIVATED! (See pages 14-15)

Example: To program cooking at DEFROST power for 1 minute and at HIGH power for 2 minutes into Number/Memory pads “1” and “5” at A side

	PAD	INSTRUCTION	DIGITAL DISPLAY WINDOW
		Follow steps 1 to 5 above.	
6		Press Power Level Selector pad once. <ul style="list-style-type: none"> The power level for 2nd stage will be indicated, 2nd Stage Heating Indicator “2” will start to blink. 	
7	2 0 0	Press Number/Memory pads “2”, “0” and “0”. <ul style="list-style-type: none"> The set heating time will appear. Note: The maximum set time for “DEFROST” and “P0” is 30 minutes, and 15 minutes for all others. However, the TOTAL TIME can be set up to 25 minutes for continuous heating (2 to 5 stage heating) that excludes “DEFROST” and “P0”.	
8		Press Prog pad. <ul style="list-style-type: none"> “PROG” and 2nd Stage Heating Indicator “2” will stop blinking. The total time for both stages will appear. This means that you have completed programming. 	
		<ul style="list-style-type: none"> 3 seconds later, “0” will appear. 	

Note:

- Program the remaining Number/Memory pads as desired by repeating steps above.
- When “PROG” is blinking in Digital Display Window, the program can be cancelled and/or one press on Stop/Reset pad erases the programmed Number/Memory pad number.
- Repeat the above procedure to set Heating for the third stage and later stages.

How to Operate

D. PROGRAMMING DOUBLE OR TRIPLE QUANTITY PAD

THE OVEN CAN NOT BE PROGRAMMED WHEN PROGRAM LOCK IS ACTIVATED! (See pages 14-15)

Example: To program 1.5 times of heating time for double quantity into Number/Memory pads "1" and "5" at A side

PAD	INSTRUCTION	DIGITAL DISPLAY WINDOW
1	Open the door and leave it open. <ul style="list-style-type: none"> The oven lamp will turn on, and "0" will appear. 	
2	Press Prog pad. <ul style="list-style-type: none"> "PROG" will start to blink. 	
3	Press Shift (A/B/C) pad, Number/Memory pads "1" and "5". <ul style="list-style-type: none"> The selected pad number will appear and currently programmed information will be indicated. 	
4	Press Double Quantity pad. <ul style="list-style-type: none"> The currently programmed magnification number will appear. Note: 1.6 times is preset at factory. 	
5	Press Number/Memory pads "1" and "5" for 1.5 times. <ul style="list-style-type: none"> The programmed magnification number will appear. If A15 is programmed for 3 minutes, the time for the double quantity will be 4 minutes and 30 seconds. Available range is 0.1-3.0 times. 	
6	Press Prog pad. <ul style="list-style-type: none"> "PROG" will stop blinking. This means that you have completed programming. 	
<ul style="list-style-type: none"> 3 seconds later, "0" will appear. 		

Note: If you want to program your desired magnification number for triple quantity, repeat as above, using Triple Quantity pad instead of Double Quantity pad.

All models except Model No. NE-1772 also display the memory number in steps 4, 5, and 6.

E. PROGRAM LOCK

◆ To Activate Program Lock:

PAD	INSTRUCTION	DIGITAL DISPLAY WINDOW
1	Open the door and leave it open. <ul style="list-style-type: none"> The oven lamp will turn on, and "0" will appear. 	
2	+ While pressing Start pad, press Prog pad until "PROG", "P" and "L" appear. (more than 2 seconds) <ul style="list-style-type: none"> "PROG", "P" and "L" will appear. 3 seconds later, "0" will appear. 	

In Program Lock mode:

- The oven is started by pressing the desired Number/Memory pad. There is no need to press Start pad.
- The oven can not be programmed or run manually until the program lock is released.

How to Operate

◆ To Release Program Lock:

PAD	INSTRUCTION	DIGITAL DISPLAY WINDOW
1	Open the door and leave it open. ☛ The oven lamp will turn on, and "0" will appear.	
	While pressing Start pad, press Prog pad until "PROG" and "P" appear. (more than 2 seconds) ☛ "PROG" and "P" will appear. 3 seconds later, "0" will appear.	

In Program Unlock mode:

- Oven reverts to a two-press operating mode (Number/Memory pad + Start pad).
- Repeat and interrupt feature are operational.
- Number/Memory pads can be programmed.
- Tone loudness control, length control and pitch control (beep tone at the end of heating cycle / filter cleaning alarm) are operational.

F. BEEP TONE

THE OVEN CAN NOT BE PROGRAMMED WHEN PROGRAM LOCK IS ACTIVATED! (See pages 14-15)















The loudness of beep tone, the length of beep tone at the end of heating cycle, the pitch of beep tone at the end of heating cycle and the pitch of filter cleaning alarm can be set.

Begin with step 1 and follow the procedure to change either the length of beep tone at the end of heating cycle, the pitch of beep tone at the end of heating cycle or the pitch of filter cleaning alarm.

Example: Change the volume to "middle (2bEEP)", the length of beep tone at the end of heating cycle to 2nd, the pitch of beep tone at the end of heating cycle to "Low", and the pitch of filter cleaning alarm to "Low".

PAD	INSTRUCTION	DIGITAL DISPLAY WINDOW
1	Open the door and leave it open. ☛ The oven lamp will turn on, and "0" will appear.	
	Press Prog pad.	
	Press Start pad. ☛ "PROG" will start to blink. The display changes to "3bEEP", "2bEEP", "1bEEP", and "0bEEP" each time the pad is pressed and the settings change. *The loudness of beep tone 3bEEP: loudest, 2bEEP: middle, 1bEEP: quietest, 0bEEP: silent	
	Press Prog pad. ☛ "PROG" will stop blinking, and the set loudness of beep tone will appear for 3 seconds. Then "0" will appear.	
To proceed to Step 5, press Start pad before "0" is displayed after Step 4.		













How to Operate

	PAD	INSTRUCTION	DIGITAL DISPLAY WINDOW
5		<p>Within 3 seconds after pressing Prog pad at step 4, press Start pad.</p> <ul style="list-style-type: none"> “PROG” will start to blink. The display changes to 1st, 2nd, and 3rd each time the pad is pressed and the settings change. <div style="border: 1px solid black; padding: 5px; margin-top: 10px;"> <p>*The length of beep tone at the end of heating cycle</p> <p>1st : 3 beeps 2nd : short beeps for 60 seconds 3rd : “Beep” sounds for 5 seconds, and then 3 beeps sound 30 seconds later and again 60 seconds later. (Buzzer reminder functions to prevent food forgotten in the oven)</p> </div>	
6		<p>Press Prog pad.</p> <ul style="list-style-type: none"> “PROG” will stop blinking, and the set length of beep tone at the end of heating cycle will appear for 3 seconds. Then “0” will appear. 	 
To proceed to Step 7, press Start pad before “0” is displayed after Step 6.			
7		<p>Within 3 seconds after pressing Prog pad at step 6, press Start pad.</p> <ul style="list-style-type: none"> “PROG” will start to blink. The display changes to “•”, “••”, and “•••” each time the pad is pressed and the settings change (Under the “bE” in “bEEP”). <div style="border: 1px solid black; padding: 5px; margin-top: 10px;"> <p>*The pitch of beep tone at the end of heating cycle</p> <p>• : Low, •• : Normal, ••• : High</p> </div>	
8		<p>Press Prog pad.</p> <ul style="list-style-type: none"> “PROG” will stop blinking, and the set pitch of beep tone at the end of heating cycle will appear for 3 seconds. Then “0” will appear. 	 
To proceed to Step 9, press Start pad before “0” is displayed after Step 8.			
9		<p>Within 3 seconds after pressing Prog pad at step 8, press Start pad.</p> <ul style="list-style-type: none"> “PROG” will start to blink. The display changes to “•”, “••”, and “•••” each time the pad is pressed and the settings change (Under the “EP” in “bEEP”). <div style="border: 1px solid black; padding: 5px; margin-top: 10px;"> <p>*The pitch of filter cleaning alarm</p> <p>• : Low, •• : Normal, ••• : High</p> </div>	
10		<p>Press Prog pad.</p> <ul style="list-style-type: none"> “PROG” will stop blinking, and the set pitch of filter cleaning alarm will appear for 3 seconds. Then “0” will appear. 	 

Note: When the filter cleaning alarm counter setting is “0”, you cannot perform steps 9 and 10.

How to Operate

G. PROGRAM LIST

	PAD	INSTRUCTION	DIGITAL DISPLAY WINDOW
1		<p>Open the door and leave it open.</p> <ul style="list-style-type: none"> The oven lamp will turn on and “0” will appear. 	
2	 + 	<p>While pressing Start pad, press Number/Memory pad “1”.</p> <ul style="list-style-type: none"> All currently programmed information (the program set into each Number/Memory pad [A/B/C sides (000 to 999)], Beep Tone, Program Lock, Oven Lamp settings when the door is open, Oven Lamp blink settings at the end of heating cycle and Oven Lamp reduction settings during cooking information) will continuously appear. <p>Note: When the filter cleaning alarm counter is set, this appears after Program Lock.</p>	<p>e.g.</p>          

How to erase memory content

1. Open the door (keep it open) and press Prog pad.
2. Select the memory number you want to erase, and press the Power Level Selector pad.
3. Press the Stop/Reset pad, and “0” is displayed to indicate that memory is erased.

*Memory content is automatically erased if overwritten.

How to Operate

H. CYCLE COUNTER

◆ *To display all cooking times ever used:*

	PAD	INSTRUCTION	DIGITAL DISPLAY WINDOW
1		Open the door and leave it open. ☛ The oven lamp will turn on and "0" will appear.	
2	+	While pressing Start pad, press Number/Memory pad "3". ☛ All the cooking times that were ever used appear.	e.g.

◆ *To display the cumulative number of times the oven was used:*

	PAD	INSTRUCTION	DIGITAL DISPLAY WINDOW
1		Open the door and leave it open. ☛ The oven lamp will turn on and "0" will appear.	
2	+	While pressing Start pad, press Power Level Selector pad. ☛ The number of cycles that the oven has been used will appear. Note: The last two digits are dropped from the cumulative number of times the oven was used, which is displayed in units of 100 when used over 100 times.	e.g.

I. AIR FILTER CLEANING

Example: To program cleaning Air Filter every 600 hours

	PAD	INSTRUCTION	DIGITAL DISPLAY WINDOW
1		Open the door and leave it open. ☛ The oven lamp will turn on and "0" will appear.	
2	+	While pressing Start pad, press Number/Memory pad "7". ☛ The currently programmed hour will appear.	e.g.
3		Press Number/Memory pads "6", "0" and "0". ☛ The programmed hour will appear. Note: up to 9999 hours	e.g.
4		Press Prog pad. ☛ "PROG" will stop blinking, and the set hours will appear for 3 seconds. Then "0" will appear.	e.g.

Note: When "FILt" sign appears in Digital Display Window, remove Air Filter and clean it with soapy water. Press Stop/Reset pad for 2 seconds to clear the display.

How to release the "FILt" sign

1. Press and hold down the Stop/Reset pad for 2 seconds.
2. The "FILt" sign is released and the buzzer sounds.
3. Press Stop/Reset pad, "0" will appear.

How to Operate

Example: To display the filter cleaning alarm counter

	PAD	INSTRUCTION	DIGITAL DISPLAY WINDOW
1		Open the door and leave it open. ☛ The oven lamp will turn on, and "0" will appear.	
2	+	While pressing Start pad, press Number/Memory pad "5". ☛ The cumulative total cooking time elapsed since the last time it was cleared is displayed.	e.g.
		• 3 seconds later, "0" will appear.	

J. OVEN LAMP

THE OVEN CAN NOT BE PROGRAMMED WHEN PROGRAM LOCK IS ACTIVATED! (See pages 14-15)

◆ *Oven Lamp settings when the door is open.*







Example: To turn Oven Lamp settings OFF

	PAD	INSTRUCTION	DIGITAL DISPLAY WINDOW
1		Open the door and leave it open. ☛ The oven lamp will turn on, and "0" will appear.	
2	+	While pressing Start pad, press Number/Memory pad "9". ☛ "PROG" will start to blink. The previously set Oven Lamp settings are displayed.	
3		Press Start pad. ☛ "on" → "oFF" → "on" is repeated each time the pad is pressed.	
4		Press Prog pad. ☛ "PROG" will stop blinking, and the Oven Lamp settings will appear for 3 seconds. Then "0" will appear.	
		To proceed to Step 5, press Start pad before "0" is displayed after Step 4.	

How to Operate







◆ *Oven Lamp blinks at the end of heating cycle.*

Example: To turn the blinking Oven Lamp ON at the end of heating cycle

	PAD	INSTRUCTION	DIGITAL DISPLAY WINDOW
5		<p>Within 3 seconds after pressing Prog pad at step 4, press Start pad.</p> <ul style="list-style-type: none"> “PROG” will start to blink. The previously set Oven Lamp blink settings are displayed. 	
6		<p>Press Start pad.</p> <ul style="list-style-type: none"> “oFF” → “on” → “oFF” is repeated each time the pad is pressed. 	
7		<p>Press Prog pad.</p> <ul style="list-style-type: none"> “PROG” will stop blinking, and the Oven Lamp blink settings will appear for 3 seconds. Then “0” will appear. 	 
To proceed to Step 8, press Start pad before “0” is displayed after Step 7.			

◆ *Adjusting Oven Lamp brightness during cooking.*

Example: To decrease brightness of the inner cavity during cooking

	PAD	INSTRUCTION	DIGITAL DISPLAY WINDOW
8		<p>Within 3 seconds after pressing Prog pad at step 7, press Start pad.</p> <ul style="list-style-type: none"> “PROG” will start to blink. The previously set Oven Lamp reduction settings are displayed. 	
9		<p>Press Start pad.</p> <ul style="list-style-type: none"> “oFF” → “on” → “oFF” is repeated each time the pad is pressed. 	
10		<p>Press Prog pad.</p> <ul style="list-style-type: none"> “PROG” will stop blinking, and the Oven Lamp reduction settings will appear for 3 seconds. Then “0” will appear. 	 

Installation Instructions for Stacking

IMPORTANT

1. Disconnect the power cord from the wall socket before attempting installation.
2. For stacking installation, you must use the PANASONIC Joint Plate (sold separately).
3. The combination of the units for stacking is limited to only the following PANASONIC models:
Models No. NE-12521, NE-12523, NE-17521,
NE-17523, NE-17723, NE-21521,
NE-21523
4. The **maximum** stacking height is the total heights of two units.

PREPARATION

Be sure the oven cavity is empty. Be sure surfaces where ovens meet is clean and sanitized.

INSTALLATION

1. Stack the units and remove five screws (a) as shown in Fig.1.
2. Loosen the screw (b).
3. Projection on Joint Plate must face away from the oven. Place Joint Plate on the screw (b).
4. Attach and tighten five screws (a) and the screw (b). See Fig.2.
5. Ensure the top oven is at a safe and workable height.

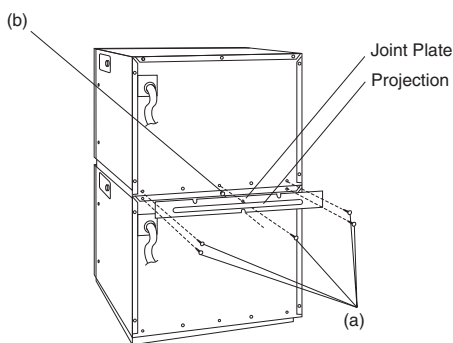

Fig. 1

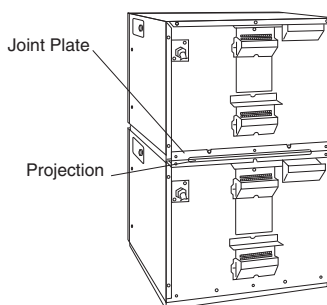

Fig. 2

Sanitary Counter Top Seal

When microwave oven units are stacked on a counter top, their base must be sealed in accordance with NSF Standards as per the following instructions.

1. Microwave oven should be located on a level counter top surface. Complete the electrical connections.
2. Thoroughly clean the microwave oven bottom perimeter and the counter top area around the microwave oven perimeter.
3. Lay generous bead of silicone seal around the entire perimeter of the base of each microwave oven unit.
4. Smooth the silicone seal into the crevice with finger or tool to provide a cove seal.

Note: Remove the Air Filter from the front of the oven before applying silicone.
DO NOT FORGET to re-install the Air Filter after applying silicone.

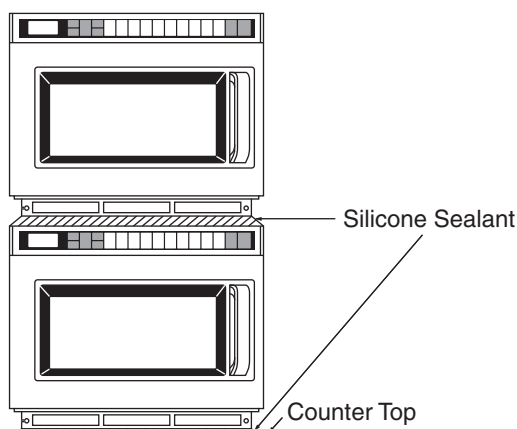

Care of Your Oven

1. Remove the plug from the electrical socket before cleaning.
2. Keep the inside of the oven clean. If pieces of food or spilled liquids stick to the oven walls, or between door seal and door surface, they will absorb microwaves and may cause arcing or sparks. Wipe up all spills with a damp cloth. Kitchen detergent or an approved sanitizing solution may be used if the oven gets very dirty. Do not use harsh detergents or abrasives.
3. The outside surface of this microwave oven should be cleaned with soap and water, then dried with a soft cloth. Make sure that water does not get into the back ventilation or control panel opening since this can damage the unit.
4. The window of the door should be washed with very mild soap and water. Be sure to use a soft cloth. Never use window cleaner. The front door can be scratched by harsh soap or cleaners.

CLEANING OF THE SPLATTER SHIELD

1. Hold snap in-snap out side stoppers of splatter shield with both hands and pull them in and down. Then take the splatter shield out of the oven cavity.

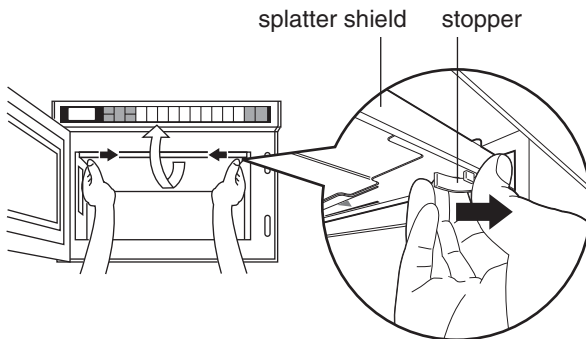

2. Rinse splatter shield in soapy water and an approved sanitizing solution.
3. Be sure to replace the shield before using the oven.

CAUTION

Splatter shield must be in place securely when you use the oven.

CLEANING THE AIR FILTER

Clean the Air Filter daily according to the following instructions. The oven may have problems when the Air Filter becomes clogged with dust. (*)

1. Remove Air Filter from the front bottom skirt by returning the right screw to the left. Then slide the filter to the right and lift it off the post at the left.

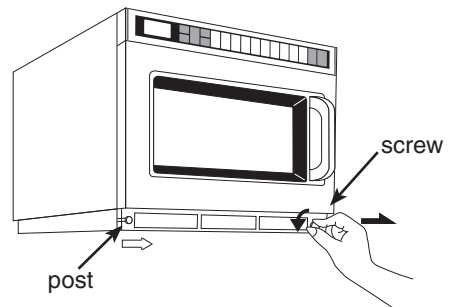

2. Wash this filter in warm soapy water.
3. Be sure to replace Air Filter before using the oven.

(*) If Air Filter becomes clogged with debris this will cause an overheating problem on the oven.- See Failure codes on page 6.

Cleaning and Maintenance procedures

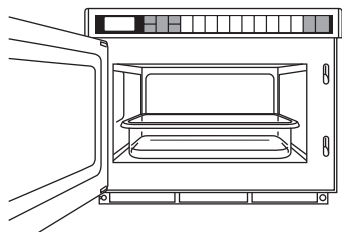

ALWAYS COVER pan(s). Use a ½ Pan for smaller portions and add a little water in pan to create steam.

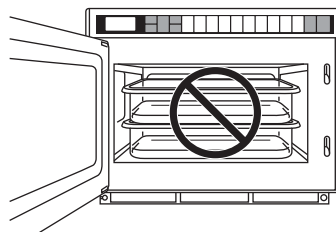

DO NOT stack pans.
DO NOT OPERATE EMPTY!

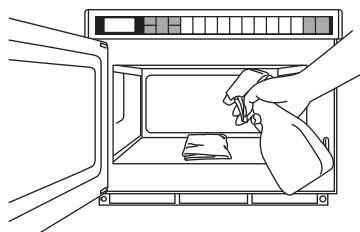

ALWAYS clean oven interior DAILY with rag SOAKED with Sanitizer, set Microwave for 1 minute and 30 seconds-this softens any hardened residue inside oven.

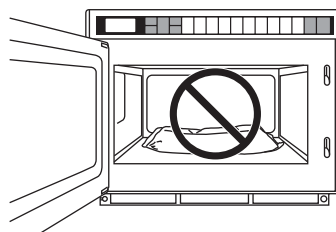

DO NOT HEAT BAGGED PRODUCTS!
Place the food in a microwave-safe container with a lid and heat or defrost.

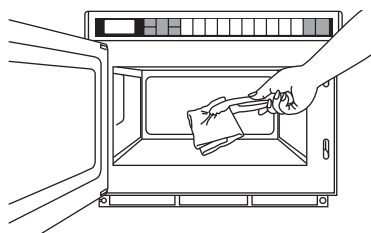

The rag will now be very hot.
CAREFULLY, and without scraping, wipe interior with the cloth using tongs.

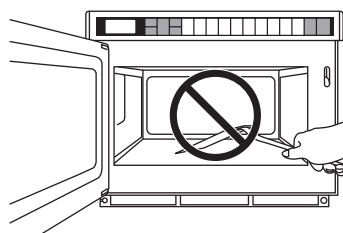

DO NOT use utensils or metal objects to clean interior of oven.
DO NOT use oven as a Timer.

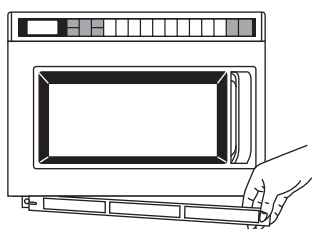

ALWAYS remove bottom filter screens and clean daily. DO NOT OPERATE OVEN EMPTY OR WITHOUT FILTER SCREENS. Vent holes behind filters should be open & clean. Use a small brush to clean as necessary.

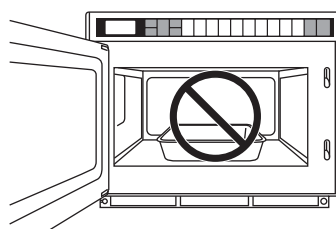

DO NOT operate with Metal pans.
Use covered Amber "H" type pans or microwaveable containers only!

IF BOTTOM PLATE BREAKS or CRACKS, DO NOT CONTINUE TO USE OVEN CONTACT AUTHORIZED SERVICE AGENCY IMMEDIATELY!! 1-888-350-9590

Heating and Defrosting Time Charts

TABLE OF CONTENTS

MICROWAVE BASICS	25
GENERAL GUIDELINES FOR HEATING IN PANASONIC MICROWAVE OVEN.	25
APPETIZERS	26
BAKED GOODS AND DESSERTS	27
BREAKFAST	28
FISH AND SEAFOOD	30
GRAVIES, SAUCES AND SOUPS	31
PLATED MEAT AND POULTRY ENTREES	32
RICE AND PASTA	33
SANDWICHES	34
VEGETABLES	35
CASSEROLES	37

Note: All heating times in the following charts are “approximate”. We recommend you test your own recipe items and plating techniques in this oven to establish the correct heating times for your recipe items.

Maximum programmable time for each stage heating is

“DEFROST” and “P0”: 30 minutes

others: 15 minutes.

Example: For items that cook longer than 15 minutes on MEDIUM power, please program oven for two or three stage cooking.

For example: To program 35 minutes on MEDIUM

1st stage: Program on MEDIUM 15 minutes

2nd stage: Program on MEDIUM 15 minutes

3rd stage: Program on MEDIUM 5 minutes

TOTAL TIME on MEDIUM is 35 minutes

Heating and Defrosting Time Charts

MICROWAVE BASICS

Fundamental principles determine the success of microwave food preparation.

They include:

1. **TEMPERATURE OF FOODS** — Frozen or refrigerated food items will require longer heating times to reach a desired serving temperature than foods from room temperature.
2. **FOOD COMPONENTS** — Foods high in sugar, salt, fats and moisture content heat faster because these properties attract microwave energy. Denser foods high in protein and fiber, absorb microwave energy slower which means a lengthier heating time.
3. **BULK/VOLUME** — The greater the mass of food, the longer it takes to heat.
4. **CONTAINERS** — Ceramic, paper, china, styrofoam, glass and plastic are suitable for use in microwave ovens with the following caution.

DO NOT HEAT foods in a **SHIELD** container or

Heating foods with either high sugar or high fat content should be done. **ONLY** in high temperature-resistant containers since these foods get very hot. Using styrofoam containers for these foods will cause the styrofoam to warp. Other low temperature restaurant glass or plastic platters may crack or warp under similar conditions.

bag. Foods expand when heated and can break the container or bag.

5. **AVOID METAL** because it “bounces” the microwaves, causing uneven heating and sometimes even flashes, which may pit or mar the interior of the oven, the metal container or plate trim.
6. Heated liquids can erupt if not mixed with air. Do not heat liquids in your microwave oven without first stirring.

GENERAL GUIDELINES FOR HEATING IN A PANASONIC MICROWAVE OVEN

For specific time, see each food category for appropriate heating techniques, plus necessary pre-preparation of foods.

HEATING FOODS FROM REFRIGERATED TEMPERATURE

Foods stored in the refrigerator (40°F) should be covered before reheating with the exception of breads, pastries or any breaded product, which should be heated uncovered to prevent sogginess.

Most conventionally prepared foods should be slightly undercooked, and held in the refrigerator, so that overcooking does not occur during microwave heating.

Cooked items, such as vegetables, may be portion plated and covered for reheating without loss of color, texture or nutritional content.

HEATING FOODS FROM ROOM TEMPERATURE

Food items such as canned entree, vegetables, etc. will require significantly less heating time than those from refrigerated temperatures.

IMPORTANT RECOMMENDATIONS

1. For best results it is recommended that foods conventionally prepared be slightly undercooked when subsequently heated in this oven.
2. **REMEMBER** that after the heating cycle has been completed, internal food temperatures continue to rise slightly in foods heated in this oven.
3. A major abuse of microwave applications is the category of breads, pastries and pies are drier than insides or fillings, they heat more slowly. Therefore, baked goods should **ONLY** be heated until the crust is warm to the touch (120°F-130°F).
4. **DO NOT OVERHEAT YOUR FOOD: 99% of all food quantity complaints of microwave heated foods can be traced to overheating.**

Heating and Defrosting Time Charts

APPETIZERS

Quantities of appetizers can be prepared conventionally in advance and refrigerated until needed. Most appetizers, with the exception of “nacho” platters and potato skins, should be heated covered. Appetizers of the same basic shape and size can be reheated together.

Most cooked appetizers heat on HIGH power, between 7 and 11 seconds per ounce depending on weight, density, and bone content. “Nacho’s” need 30 to 37 seconds per ounce depending on the amount of topping.

All heating times listed in the chart are from refrigerated temperatures (40°F) except for “nacho” chips.

Item	Quantity	Instructions for Pre-preparation	Instructions for Microwave Heating	Power Setting	Approximate Times		
					NE-12521 NE-12523	NE-17521 NE-17523 NE-17723	NE-21521 NE-21523
BBQ Ribs	8 oz. (224 g)	Prepare conventionally, refrigerate, covered.	Place on plate, cover.	HIGH	60 sec.	45 sec.	35 sec.
Chicken Wings	5-6 oz. (140-168 g)	Prepare conventionally, refrigerate, covered.	Place on plate, cover.	HIGH	50 sec.	35 sec.	25 sec.
Chili con Queso	8 oz. (224 g)	Prepare conventionally, refrigerate, covered.	Place in small bowl, cover.	HIGH	1 min. 15 sec.	50 sec.	40 sec.
Meatballs	4-5 oz. (112-140 g)	Prepare conventionally, refrigerate, covered.	Place on plate, cover.	HIGH	50 sec.	35 sec.	25 sec.
Nachos	4 oz. (112 g)	For Best Results- Prepare when ordered or only a short time before serving to keep chips crisp.	Spread refried beans on each individual nacho. Arrange on platter. Sprinkle with Cheddar cheese. DO NOT COVER.	HIGH	50 sec.	35 sec.	25 sec.
Potato Skins	8 oz. (224 g)	Prepare skins conventionally, refrigerate, covered.	Arrange skins on platter. Sprinkle with shredded Cheddar cheese and cooked, crumbled bacon. DO NOT COVER.	HIGH	60 sec.	45 sec.	35 sec.
Rumaki	4 oz. (112 g)	Prepare conventionally, refrigerate, covered.	Place on plate, cover.	HIGH	35 sec.	25 sec.	20 sec.
Shrimp de Jonghe	4 oz. (112 g)	Prepare conventionally, refrigerate, covered.	Place on small plate, cover.	HIGH	55 sec.	40 sec.	30 sec.

Heating and Defrosting Time Charts

BAKED GOODS AND DESSERTS

Breads, pastries and pies should be heated uncovered, at HIGH power. They should be placed on absorbent material, such as a napkin or paper towel to prevent sogginess.

DO NOT OVERHEAT breads and pastries. Baked goods should only be heated until the crust feels warm to the touch (120°F-130°F).

Because crusts of breads, pastries and pies are drier than insides or fillings, they heat more slowly. After heating let rest about 1 minutes for equalization of temperature. If product is overheated, the end result will not be satisfactory.

Heating times for sweet baked goods and desserts are relatively short because of the high sugar content.

Item	Quantity	Instructions for Pre-preparation	Instructions for Microwave Heating	Power Setting	Approximate Times		
					NE-12521 NE-12523	NE-17521 NE-17523 NE-17723	NE-21521 NE-21523
Bread, mini-loaf white or wheat	8 oz. (224 g)	Prepare conventionally, store at room temperature.	Place on paper towel, uncovered.	HIGH	25 sec.	15 sec.	10 sec.
Coffee cake frozen	3 oz. (84 g)		Place on paper towel, uncovered.	HIGH	20 sec.	13 sec.	7 sec.
Muffins, fruit	2 ea.	Prepare conventionally or defrost, store at room temperature.	Place on paper towel, or napkin, uncovered.	HIGH	20 sec.	13 sec.	7 sec.
	6 ea.	Prepare conventionally or defrost, store at room temperature.	Place on paper towel, or napkin, uncovered.	HIGH	30 sec.	20 sec.	15 sec.
Pie, fruit	5 oz. (1 slice 140 g)	Prepare conventionally, refrigerate, covered.	Place on plate, uncovered.	HIGH	25 sec.	15 sec.	10 sec.
Rolls, hard	4 ea.	Room temperature.	Place on paper towel, uncovered. After heating, let rest 1 minute.	HIGH	25 sec.	15 sec.	10 sec.
Rolls, soft	6 ea.	Room temperature.	Place on paper towel, uncovered. After heating, let rest 1 minute.	HIGH	25 sec.	15 sec.	10 sec.
Rolls, sweet	6 ea.	Room temperature.	Place on paper towel, uncovered. After heating, let rest 1 minute.	HIGH	25 sec.	15 sec.	10 sec.

Heating and Defrosting Time Charts

BREAKFAST

All foods listed are prepared in advance and reheated at HIGH power from refrigerated temperatures (40°F).

Most breakfast foods are heated covered to retain moisture, with the exception of breads and pastries, which should be heated uncovered on absorbent material such as a napkin or paper towel to prevent sogginess. For poached eggs, pierce yolks before heating and allow eggs to stand for 1 minute after cooking so pressure subsides before cutting into them.

When preparing breakfast foods conventionally, undercook slightly and immediately chill and store, covered, for later reheating.

Cured breakfast meats will reheat faster than uncured meats because salt readily absorbs microwave energy.

WARNING: Never cook or reheat eggs in the shell. They may explode when interior pressure builds up.

Item	Quantity	Instructions for Pre-preparation	Instructions for Microwave Heating	Power Setting	Approximate Times		
					NE-12521 NE-12523	NE-17521 NE-17523 NE-17723	NE-21521 NE-21523
Bacon	4 strips	Prepare conventionally, undercook slightly, refrigerate, covered.	Place on plate and cover.	HIGH	30 sec.	20 sec.	15 sec.
Bacon, Canadian	4 slices	Prepare conventionally, refrigerate, covered.	Place on plate and cover.	HIGH	30 sec.	20 sec.	15 sec.
Eggs, poached	2 eggs	Prepare conventionally, undercook slightly, refrigerate in salted water, covered.	Remove from water. Place on plate, pierce yolks, cover. Let rest 1 minute after heating.	HIGH	30 sec.	20 sec.	15 sec.
Eggs, scrambled	2 eggs	Prepare conventionally, undercook slightly, refrigerate, covered.	Place on plate and cover.	HIGH	30 sec.	20 sec.	15 sec.
Eggs, scrambled with bacon	2 eggs 4 strips	Prepare conventionally, undercook slightly, refrigerate, covered.	Place on plate and cover.	HIGH	35 sec.	25 sec.	20 sec.
Eggs, scrambled with sausage links	2 eggs 4 links	Prepare conventionally, undercook slightly, refrigerate, covered.	Place on plate and cover.	HIGH	45 sec.	30 sec.	20 sec.
French toast	3 slices	Prepare conventionally, refrigerate, covered.	Place toast on plate. Heat uncovered.	HIGH	35 sec.	20 sec.	15 sec.

Heating and Defrosting Time Charts

Item	Quantity	Instructions for Pre-preparation	Instructions for Microwave Heating	Power Setting	Approximate Times		
					NE-12521 NE-12523	NE-17521 NE-17523 NE-17723	NE-21521 NE-21523
French toast with bacon	2 slices 4 strips	Prepare conventionally, refrigerate, covered.	Place toast on plate in single layer. Cover	HIGH	45 sec.	35 sec.	30 sec.
French toast with sausage	2 slices 4 links	Prepare conventionally, refrigerate, covered.	Place toast on plate in single layer. Cover	HIGH	45 sec.	35 sec.	30 sec.
Ham steak	4 oz. (112 g)	Prepare conventionally, refrigerate, covered.	Place on plate and cover. Let rest 1 minute after heating.	HIGH	40 sec.	30 sec.	25 sec.
Hash, corned beef, canned	3 oz. (84 g)	Prepare conventionally, refrigerate, covered.	Place on plate and cover.	HIGH	45 sec.	30 sec.	25 sec.
Pancakes	4 ea.	Prepare conventionally, refrigerate, covered.	Place on plate in single layer. Heat uncovered.	HIGH	35 sec.	20 sec.	15 sec.
Pancakes with bacon	4 ea. 4 strips	Prepare conventionally, refrigerate, covered.	Place on plate in single layer. Cover.	HIGH	45 sec.	35 sec.	30 sec.
Pancakes and sausage patty	4 oz. (4 ea. 112 g)	Prepare conventionally, refrigerate, covered.	Place on plate in single layer. Cover.	HIGH	45 sec.	35 sec.	30 sec.
Potatoes, hashed brown	4½ oz. (126 g)	Prepare conventionally, refrigerate, covered.	Place on plate and heat, uncovered.	HIGH	40 sec.	30 sec.	25 sec.
Sausage links	4 links	Prepare conventionally, undercook slightly, refrigerate, covered.	Place on plate. Cover.	HIGH	40 sec.	30 sec.	25 sec.
Sausage patties	4 patties	Prepare conventionally, undercook slightly, refrigerate, covered.	Place on plate. Cover.	HIGH	35 sec.	25 sec.	20 sec.

Heating and Defrosting Time Charts

FISH AND SEAFOOD

Defrost

Fish and seafood can be defrosted and heated successfully in this microwave oven. To defrost evenly, fish should be arranged in a single layer in container and should only be thawed to the point of being flexible so it does not begin to cook at the edges.

Primary Cooking

Cooking individual portions demands close attention as well as slight undercooking. Delicate fish and shellfish should always be undercooked and should rest after heating.

Fish/Seafood—Primary Cooking

Item	Quantity	Instructions for Pre-preparation	Instructions for Microwave Heating	Power Setting	Approximate Times		
					NE-12521 NE-12523	NE-17521 NE-17523 NE-17723	NE-21521 NE-21523
Lobster Tail	8 oz. (224 g)	Defrost. Refrigerate, covered.	Place on plate, brush with butter and cover.	HIGH	3 min. 30 sec.	2 min. 30 sec.	1 min. 30 sec.
Perch fillets	7 oz. (196 g)	Defrost. Refrigerate, covered.	Place in microwave pan and brush with butter and herbs.	HIGH	1 min. 15 sec.	50 sec.	40 sec.
Salmon Steaks	8 oz. (224 g)	Defrost. Refrigerate, covered.	Place on plate, brush with butter and cover.	HIGH	1 min.	45 sec.	35 sec.
Scallops, Bay	5 oz. (140 g)	Defrost slightly. Refrigerate, covered.	Place in microwave pan, dot with butter and cover.	HIGH	45 sec.	35 sec.	30 sec.
Shrimp, large	6 oz. (168 g)	Defrost. Refrigerate, covered.	Place on plate and cover.	HIGH	45 sec.	35 sec.	30 sec.
Snapper, Red fillets	5 oz. (140 g)	Defrost. Refrigerate, covered.	Place on plate, brush with butter and herbs and cover.	HIGH	1 min.	45 sec.	35 sec.
Sole, stuffed with crabmeat	6 oz. (168 g)	Defrost. Refrigerate, covered.	Place on plate and cover.	HIGH	1 min. 15 sec.	50 sec.	40 sec.

Fish/Seafood, Frozen—Defrosting (To calculate time, use 15 seconds times (x) ounce)

Item	Quantity	Instructions for Pre-preparation	Instructions for Microwave Heating	Power Setting	Approximate Times		
					NE-12521 NE-12523	NE-17521 NE-17523 NE-17723	NE-21521 NE-21523
Lobster Tail (frozen)	8 oz. (224 g)		Place on plate and cover. After DEFROST cycle, let rest 5 min. and refrigerate or cook.	DEFROST		Use calculation Above	
Perch, fillets (frozen)	1 lb. (450 g)		Place in microwave pan and cover. Halfway through defrost, turn over and if possible, rearrange fillets. After DEFROST cycle, let rest 5 min. and refrigerate or cook.	DEFROST		Use calculation Above	
Shrimp, large (frozen)	6 oz. (168 g)		Place on plate and cover. After DEFROST cycle, refrigerate or cook.	DEFROST		Use calculation Above	

Heating and Defrosting Time Charts

GRAVIES, SAUCES AND SOUPS

Some water-based gravies, sauces and soup mixes may be prepared in large portions using this oven to heat water and thicken the blended mixes.

Refrigerated gravies, sauces and soups can be reheated quickly at HIGH and requires stirring during heating to produce an even temperature.

Gravies

Item	Quantity	Instructions for Pre-preparation	Instructions for Microwave Heating	Power Setting	Approximate Times		
					NE-12521 NE-12523	NE-17521 NE-17523 NE-17723	NE-21521 NE-21523
Brown gravy	1 qt.	Prepare conventionally, or heat ingredients in microwave, if recommended. Refrigerate gravy.	Place in microwave pan. Cover, stir midway and cover.	HIGH	7 min.	5 min. 30 sec.	4 min. 30 sec.
Chicken gravy	1 qt.			HIGH	5 min.	5 min.	4 min. 30 sec.

Sauces

Item	Quantity	Instructions for Pre-preparation	Instructions for Microwave Heating	Power Setting	Approximate Times		
					NE-12521 NE-12523	NE-17521 NE-17523 NE-17723	NE-21521 NE-21523
Au jus	1 qt.	Prepare conventionally, or heat ingredients in microwave, if recommended. Refrigerate sauce.	Place in microwave pan. Cover, stir midway through heating.	HIGH	7 min.	5 min. 30 sec.	4 min. 30 sec.
Cheese sauce	1 qt.			HIGH	8 min.	6 min. 30 sec.	5 min. 30 sec.
Espagnole (stock base)	1 qt.			HIGH	7 min.	5 min. 30 sec.	4 min. 30 sec.
Mushroom sauce	1 qt.			HIGH	7 min.	5 min. 30 sec.	4 min. 30 sec.
Tomato sauce	1 qt.			HIGH	7 min.	5 min. 30 sec.	4 min. 30 sec.
White sauce (Bechamel)	1 qt.			HIGH	7 min.	5 min. 30 sec.	4 min. 30 sec.
White sauce (stock base)	1 qt.			HIGH	7 min.	5 min. 30 sec.	4 min. 30 sec.

Soups

Item	Quantity	Instructions for Pre-preparation	Instructions for Microwave Heating	Power Setting	Approximate Times		
					NE-12521 NE-12523	NE-17521 NE-17523 NE-17723	NE-21521 NE-21523
Beef broth	1 qt.	Prepare conventionally, or heat ingredients in microwave, if recommended. Refrigerate soup.	Place in microwave pan. Cover, stir midway through heating.	HIGH	7 min.	5 min. 30 sec.	4 min. 30 sec.
Chicken Noodle soup	1 qt.			HIGH	7 min.	5 min. 30 sec.	4 min. 30 sec.
Clam chowder	1 qt.			HIGH	7 min.	5 min. 30 sec.	4 min. 30 sec.

Heating and Defrosting Time Charts

PLATED MEAT AND POULTRY ENTREES

Meat and poultry can be reheated successfully in this oven.

Undercook meat slightly. Arrange meat or poultry slices in single layer, overlapping pieces as little as possible.

CAUTION

Pork products must be fully cooked prior to reheating.

When appropriate, cover meats or poultry evenly with sauces.

Item	Quantity	Instructions for Pre-preparation	Instructions for Microwave Heating	Power Setting	Approximate Times		
					NE-12521 NE-12523	NE-17521 NE-17523 NE-17723	NE-21521 NE-21523
Beef, prime rib au jus	12 oz. (336 g)	Prepare conventionally, refrigerate, covered.	Place on plate and top meat with au jus. Cover.	HIGH	2 min.	1 min. 20 sec.	1 min.
Beef stew	8 oz. (224 g)	Prepare conventionally, refrigerate, covered.	Put in small bowl, stir midway through heating, cover.	HIGH	1 min.	45 sec.	35 sec.
Beef stroganoff with noodles	8 oz. (224 g)	Prepare conventionally, refrigerate, covered.	Place on plate and cover.	HIGH	35 sec.	45 sec.	15 sec.
Chicken, BBQ	9 oz. (252 g)	Prepare conventionally, refrigerate, covered.	Place on plate, cover. After 30 sec. of heating, spoon additional sauce evenly over chicken, if desired.	HIGH	1 min. 30 sec.	1 min.	45 sec.
Chicken, breaded, fried	8 oz. (224 g)	Prepare conventionally, refrigerate, covered.	Place on plate, uncovered.	HIGH	1 min.	45 sec.	35 sec.
Chicken, broiled	½ ea.	Prepare conventionally, refrigerate, covered.	Place on plate and cover.	HIGH	1 min. 30 sec.	1 min.	45 sec.
Chicken pieces, with potatoes, dressing and gravy	12 oz. (336 g)	Prepare all components conventionally, refrigerate, covered	Place on plate, depress potatoes and cover.	HIGH	3 min.	2 min.	1 min. 30 sec.
Cornish hen	1 ea. (22 oz.)	Prepare conventionally, refrigerate, covered.	Place on plate and cover.	HIGH	2 min. 30 sec.	2 min.	1 min. 30 sec.
Duck	½ ea.	Prepare conventionally, refrigerate, covered.	Place on plate and cover.	HIGH	3 min.	2 min.	1 min. 30 sec.
Burrito	8 oz. (224 g)	Prepare conventionally, refrigerate, covered.	Place on plate and cover.	HIGH	1 min.	45 sec.	35 sec.
Meat loaf with gravy	7 oz. (196 g)	Prepare conventionally, refrigerate, covered.	Arrange slices in single layer on plate, cover with gravy. Cover	HIGH	1 min. 10 sec.	50 sec.	45 sec.
Green peppers, stuffed	6 oz. (168 g)	Prepare conventionally, refrigerate, covered.	Place on plate and cover.	HIGH	1 min. 45 sec.	1 min. 15 sec.	50 sec.
Pork chop, stuffed	7 oz. (196 g)	Prepare conventionally, refrigerate, covered.	Place on plate and cover.	MEDIUM	2 min.	1 min. 30 sec.	1 min. 10 sec.
Ribs, short	8 oz. (224 g)	Prepare conventionally, refrigerate, covered.	Place on plate and cover.	HIGH	1 min.	45 sec.	35 sec.
Ribs, spare	16 oz. (448 g)	Prepare conventionally, refrigerate, covered.	Place on plate and cover.	HIGH	2 min.	1 min. 30 sec.	1 min. 10 sec.
Salisbury steak	7 oz. (196 g)	Prepare conventionally, refrigerate, covered.	Place on plate and cover.	MEDIUM	2 min.	1 min. 30 sec.	1 min. 10 sec.
Turkey, sliced with gravy	12 oz. (336 g)	Prepare conventionally, refrigerate, covered with gravy. Cover.	Arrange slices in single layer on plate and cover.	HIGH	1 min. 10 sec.	50 sec.	45 sec.

Heating and Defrosting Time Charts

RICE AND PASTA

For best results: reheat covered at HIGH power. Adding moisture, such as a sauce, can facilitate reheating though its not essential.

Rice and pasta dishes with cheese sauce, require more stirring than tomato-based sauces to avoid over-heating and stringiness of cheese.

Rice

Item	Quantity	Instructions for Pre-preparation	Instructions for Microwave Heating	Power Setting	Approximate Times		
					NE-12521 NE-12523	NE-17521 NE-17523 NE-17723	NE-21521 NE-21523
Chicken rice pilaf	4 oz. (112 g)	Prepare conventionally, undercook slightly, refrigerate, covered.	Place on plate and cover.	HIGH	50 sec.	35 sec.	25 sec.
Rice, long grain and wild rice	4 oz. (112 g)	Prepare conventionally, undercook slightly, refrigerate, covered.	Place on plate and cover.	HIGH	50 sec.	35 sec.	25 sec.

Pasta

Item	Quantity	Instructions for Pre-preparation	Instructions for Microwave Heating	Power Setting	Approximate Times		
					NE-12521 NE-12523	NE-17521 NE-17523 NE-17723	NE-21521 NE-21523
Lasagna	8 oz. (224 g)	Prepare conventionally, undercook slightly, refrigerate, covered.	Place on plate and cover. Cut in half, let rest 1 min. after heating.	HIGH	2 min.	1 min. 30 sec.	1 min. 30 sec.
				MEDIUM	1 min. 30 sec.	1 min.	50 sec.
Macaroni and cheese	8 oz. (224 g)	Prepare conventionally, undercook slightly, refrigerate, covered.	Place on plate and cover. Let rest 1 min. after heating.	HIGH	1 min. 30 sec.	1 min. 10 sec.	50 sec.
Noodles	4 oz. (112 g)	Prepare conventionally, undercook slightly, refrigerate, covered.	Place on plate and cover.	HIGH	45 sec.	30 sec.	20 sec.
Ravioli	6 oz. (168 g)	Prepare conventionally, undercook slightly, refrigerate, covered.	Arrange in single layer on small place and cover.	HIGH	55 sec.	40 sec.	30 sec.
	12 oz. (336 g)	Prepare conventionally, undercook slightly, refrigerate, covered.	Arrange in single layer on small place and cover.	HIGH	2 min.	1 min. 45 sec.	1 min. 10 sec.
Spaghetti with meat sauce	12 oz. (336 g)	Prepare conventionally, keeping spaghetti and sauce separate, refrigerate, covered.	Place on plate and cover with sauce. Cover.	HIGH	1 min. 50 sec.	1 min. 30 sec.	1 min. 15 sec.

Heating and Defrosting Time Charts

SANDWICHES

Preassembled sandwiches can be heated quickly and easily in this microwave oven. For best results, assemble sandwiches no more than 3 hours in advance. Meat fillings such as hamburgers and sausage should be precooked and preferably not be more than ½ inch thick.

Day-old, toasted breads, or breads whose formula is enriched with egg or fat are advantageous because they tend to become less soggy when heated.

Thin sliced meats, lightly packed, allow for more even heating. Place meat over bread.

All but openfaced sandwiches should be heated uncovered on absorbent material such as paper towel or napkin to prevent sogginess.

Item	Quantity	Instructions for Pre-preparation	Instructions for Microwave Heating	Power Setting	Approximate Times		
					NE-12521 NE-12523	NE-17521 NE-17523 NE-17723	NE-21521 NE-21523
BBQ beef on bun	6 oz. (168 g)	Prepare beef conventionally, refrigerate, covered. Toast bun.	Assemble, place on paper napkin on plate, uncovered.	HIGH	60 sec.	45 sec.	35 sec.
Corned beef on rye	5 oz. (140 g)	Assemble, refrigerate, covered.	Place on paper towel, uncovered.	HIGH	60 sec.	45 sec.	35 sec.
French dip	6 oz. (168 g)	Assemble, refrigerate, covered.	Place on plate with au jus over beef and on side, uncovered.	HIGH	60 sec.	45 sec.	35 sec.
Grilled cheese	4 oz. (112 g)	Prepare conventionally, refrigerate, covered.	Place on paper towel, uncovered.	HIGH	60 sec.	45 sec.	35 sec.
Hamburger, plain with cheese	5 oz. (140 g)	Prepare burger conventionally, Toast bun. Assemble, refrigerate, covered.	Place on paper towel, uncovered.	HIGH	60 sec.	45 sec.	35 sec.
	5 oz. (140 g)			HIGH	1 min. 5 sec.	50 sec.	40 sec.
Hot dog	3 oz. (84 g)	Prepare conventionally. Toast bun. Assemble, refrigerate, covered.	Wrap loosely in plastic.	HIGH	55 sec.	40 sec.	30 sec.
Pastrami on rye	5 oz. (140 g)	Assemble, refrigerate, covered.	Place on paper towel, uncovered.	HIGH	60 sec.	45 sec.	35 sec.
Reuben	6 oz. (168 g)	Prepare conventionally, refrigerate, covered.	Place on paper towel, uncovered.	HIGH	60 sec.	45 sec.	35 sec.
Roast beef, open-face with gravy	8 oz. (224 g)	Prepare beef and gravy conventionally, refrigerate, covered. Toast bread.	Assemble, plate, cover.	HIGH	60 sec.	45 sec.	35 sec.
Sausage, Italian on sub roll	5½ oz. (154 g)	Prepare sausage conventionally. Toast roll. Assemble, refrigerate, covered.	Place on paper towel, uncovered.	HIGH	60 sec.	45 sec.	35 sec.
Turkey, open-face with gravy	8 oz. (224 g)	Prepare turkey and gravy conventionally, refrigerate, covered. Toast bread.	Assemble, plate, cover.	HIGH	60 sec.	45 sec.	35 sec.

Heating and Defrosting Time Charts

VEGETABLES

Most vegetables, small and bulk portions, defrost, heat, and cook very successfully in the microwave, retaining fresh color and texture as well as nutritional value. The thicker and more fibrous the vegetable, the longer the cooking time. (ie. Root vegetables)

Frozen vegetables can be defrosted and heated in one step. One to two tablespoons of water should be added to frozen vegetables.

Icy sections should be broken up during heating for even temperature distribution.

Canned vegetables can be heated using HIGH in approximately 1 minute per pound.

Most fresh vegetables are prepared with a small amount of cooking liquid such as water.

Vegetables, Frozen—Defrosting and Heating

Item	Quantity	Instructions for Pre-preparation	Instructions for Microwave Heating	Power Setting	Approximate Times		
					NE-12521 NE-12523	NE-17521 NE-17523 NE-17723	NE-21521 NE-21523
Beans, green	4 lb.	NONE	Place in a microwave safe 6" half pan. Add one to two tablespoons of water. Cover with lid. Let stand, covered, 2 minutes.	HIGH	4 min./lb.	3 min./lb.	2 min./lb.
	6 lb.	NONE		HIGH			
Cauliflower	4 lb.	NONE		HIGH			
	6 lb.	NONE		HIGH			
Broccoli	4 lb.	NONE		HIGH			
Carrots, sliced	6 lb.	NONE	HIGH				

Heating and Defrosting Time Charts

Vegetable, Fresh—Heating

Item	Quantity	Instructions for Pre-preparation	Instructions for Microwave Heating	Power Setting	Approximate Times			
					NE-12521 NE-12523	NE-17521 NE-17523 NE-17723	NE-21521 NE-21523	
Carrots & other root vegetables	(cook)	4 lb.	Peel carrots; cut into 1/8" slices.	Wash vegetables well. Cut into uniform size pieces. Place in microwave safe Cambro 4" half pan. Cover with lid. Stir midway through heating. After heating, let stand, covered, 2 minutes.	HIGH	8 min.	6 min.	5 min.
		5 lb.			HIGH	10 min.	7 min. 30 sec.	6 min. 30 sec.
		6 lb.			HIGH	12 min.	9 min.	8 min.
		7 lb.			HIGH	13 min. 30 sec.	10 min. 30 sec.	9 min. 30 sec.
	(blanch)	4 lb.	Peel carrots; cut into 1/8" slices.	Wash vegetables well. Cut into uniform size pieces. Place in microwave safe Cambro 4" half pan. Add 3 to 4 tablespoons of water. Stir midway through heating. After heating, let stand, covered, 2 minutes.	HIGH	6 min.	4 min.	3 min.
		5 lb.			HIGH	8 min. 50 sec.	5 min. 30 sec.	4 min. 30 sec.
		6 lb.			HIGH	10 min.	7 min.	6 min.
		7 lb.			HIGH	11 min. 30 sec.	8 min. 30 sec.	7 min. 30 sec.

Vegetable, Fresh—Primary Cooking

Item	Quantity	Instructions for Pre-preparation	Instructions for Microwave Heating	Power Setting	Approximate Times		
					NE-12521 NE-12523	NE-17521 NE-17523 NE-17723	NE-21521 NE-21523
Broccoli	3 lb.	Rinse broccoli. Cut into spears.	Place in a microwave safe Cambro 6" half pan. Add 2 tablespoons of water. Cover. After cooking, let stand, covered, 2 minutes.	HIGH	10 min.	7 min.	5 min.
Baked Potatoes	8 pcs. (100 ct.)		Place in a microwave safe Cambro 6" half pan. Add 2 tablespoons of water. Cover. After cooking, let stand, covered, 2 minutes.	HIGH	8 min.	7 min.	6 min.
Refried beans	6 lb. 6 oz. (#10 can)		Place in a microwave safe Cambro 6" half pan. Cover with lid. After cooking, let stand 2 minutes.	HIGH	8 min.	6 min. 30 sec.	5 min.

Heating and Defrosting Time Charts

CASSEROLES

Food-Service casseroles can be cooked successfully in this microwave oven. For best results, follow instructions below.

Preparation

Remove all casseroles from their foil baking trays, while still frozen and place in a microwave safe 4-inch half pan. Place in refrigerator and thaw for about 30 minutes per ounce.

Let stand 15 minutes before serving.

Casseroles, Frozen—Heating

Item	Quantity	Instructions for Pre-preparation	Instructions for Microwave Heating	Power Setting	Approximate Times		
					NE-12521 NE-12523	NE-17521 NE-17523 NE-17723	NE-21521 NE-21523
Vegetable Lasagna	Calculate min./lb.	Place in 4" half pan. Thaw in refrigerator for approx. 4 days.	Cover with lid. Let stand 15 minutes before serving.	1st Stage HIGH	2 min. 30 sec. per lb.	1 min. 30 sec. per lb.	1 min. per lb.
				2nd Stage MEDIUM	2 min. 30 sec. per lb.	1 min. 30 sec. per lb.	1 min. per lb.
Spinach Souffle	Calculate min./lb.	Place in 4" half pan. Thaw in refrigerator for approx. 2 days.	Cover with lid. Let stand 15 minutes before serving.	1st Stage MEDIUM	2 min. 30 sec. per lb.	1 min. 30 sec. per lb.	1 min. per lb.
				2nd Stage HIGH	2 min. 30 sec. per lb.	1 min. 30 sec. per lb.	1 min. per lb.
Deep Dish Cherry Crisp	Calculate min./lb.	Place in 4" half pan. Thaw in refrigerator.	Sprinkle with 2 tablespoons of sugar.	HIGH	2 min. 30 sec. per lb.	1 min. 30 sec. per lb.	1 min. per lb.
Macaroni and Cheese	Calculate min./lb.	Place in 4" half pan. Thaw in refrigerator for approx. 2 days.	Cover with lid. Stir after cooking.	HIGH	2 min. 30 sec. per lb.	1 min. 30 sec. per lb.	1 min. per lb.
Burritos	Calculate min./lb.	Place on paper towel.	Heat covered.	HIGH	2 min. 30 sec. per lb.	1 min. 30 sec. per lb.	1 min. per lb.

Instructions for all casseroles & large items (4 lbs. or more) that are ordinarily baked:

- 1) Defrost (see defrost method on page 35).
- 2) Heat: From refrigerated temperatures (< 40°F and > 32°F)
 - Stage 1 = High time per lb.
 - Stage 2 = Medium time per lb.

Limited Warranty (ONLY FOR U.S.A. AND PUERTO RICO)

Panasonic Consumer Marketing Company of North America,
Division of Panasonic Corporation of North America
One Panasonic Way, Secaucus, New Jersey 07094

Panasonic Pro 1 Commercial Microwave Oven Limited Warranty

Limited Warranty Coverage (For USA and Puerto Rico Only)

If your product does not work properly because of a defect in materials or workmanship, Panasonic Consumer Marketing Company (referred to as "the warrantor") will, for the length of the period indicated on the chart below, which starts with the date of original purchase ("warranty period"), at its option either (a) repair your product with new or refurbished parts, (b) replace it with a new or a refurbished equivalent value product, or (c) refund your purchase price. The decision to repair, replace or refund will be made by the warrantor.

Product or Part Name	Labor	Parts
NE-12521 NE-17521 NE-21521	1 Yr.	1 Yr. Magnetron: 3 Years
NE-12523 NE-17523 NE-17723 NE-21523	3 Years	3 Years Magnetron: 3 Years

During the "Labor" warranty period there will be no charge for labor. During the "Parts" warranty period, there will be no charge for parts. This warranty only applies to products purchased and serviced in the United States or Puerto Rico. This warranty is extended only to the original purchaser of a new product which was not sold "as is".

Service:

On-site service in the continental U.S.A. can be obtained during the warranty period from a Panasonic authorized service center. Call 1-888-350-9590, toll free, to locate an authorized service center. Defects must be communicated to The Warrantor by the Purchaser no later than thirty (30) days from the date the defect appears. If the Product shall prove, in the sole judgment of The Warrantor, to be defective in materials or workmanship during the warranty period, The Warrantor shall repair the Product within a reasonable time after notification from the Purchaser to The Warrantor. If the Product cannot be repaired after a reasonable number of attempts, The Warrantor shall provide, at The Warrantor's sole discretion, either a refund of the purchase price or a replacement unit.

IF REPAIR IS NEEDED DURING THE WARRANTY PERIOD, THE PURCHASER WILL BE REQUIRED TO FURNISH A SALES RECEIPT/PROOF OF PURCHASE INDICATING DATE OF PURCHASE, AMOUNT PAID AND PLACE OF PURCHASE. CUSTOMER WILL BE CHARGED FOR THE REPAIR OF ANY UNIT RECEIVED WITHOUT SUCH PROOF OF PURCHASE.

Limited Warranty Limits And Exclusions

This warranty ONLY COVERS failures due to defects in materials or workmanship, and DOES NOT COVER glass, plastic parts, temperature probes (if included) and normal wear and tear or cosmetic damage. The warranty ALSO DOES NOT COVER damages which occurred in shipment, or failures which are caused by products not supplied by the warrantor, or failures which result from accidents, misuse, abuse, neglect, bug infestation, mishandling, misapplication, alteration, faulty installation, set-up adjustments, maladjustment of consumer controls, improper maintenance, power line surge, lightning damage, modification, rental use of the product, service by anyone other than an authorized servicer, or damage that is attributable to acts of God.

THERE ARE NO EXPRESS WARRANTIES EXCEPT AS LISTED UNDER "LIMITED WARRANTY COVERAGE".

THE WARRANTOR IS NOT LIABLE FOR INCIDENTAL OR CONSEQUENTIAL DAMAGES RESULTING FROM THE USE OF THIS PRODUCT, OR ARISING OUT OF ANY BREACH OF THIS WARRANTY.

(As examples, this excludes damages for lost time, travel to and from the servicer, loss of or damage to media or images, data or other memory or recorded content. The items listed are not exclusive, but for illustration only.)

ALL EXPRESS AND IMPLIED WARRANTIES, INCLUDING THE WARRANTY OF MERCHANTABILITY, ARE LIMITED TO THE PERIOD OF THE LIMITED WARRANTY.

Some states do not allow the exclusion or limitation of incidental or consequential damages, or limitations on how long an implied warranty lasts, so the exclusions may not apply to you.

This warranty gives you specific legal rights and you may also have other rights which vary from state to state. If a problem with this product develops during or after the warranty period, you may contact your dealer or Service Center. If the problem is not handled to your satisfaction, then write to:

Consumer Affairs Department
Panasonic Consumer Marketing Company
661 Independence Pkwy
Chesapeake, VA 23320

PARTS AND SERVICE, WHICH ARE NOT COVERED BY THIS LIMITED WARRANTY, ARE YOUR RESPONSIBILITY.

Statute of Limitations

No suit shall be brought on an alleged breach of The Warrantor warranty more than one (1) year following expiration of the relevant warranty period.

Customer Services Directory (United States and Puerto Rico)

Obtain Product Information and Operating Assistance, locate your nearest Dealer or Service Center, by visiting our Web Site at:

<http://www.panasonic.com/cmo>

You may also contact us directly at:

1-877-CMO-OVEN (1-877-266-6836)

Monday-Friday 9am-9pm

For hearing or speech impaired TTY users, TTY: 1-877-833-8855

Accessory Purchases (United States and Puerto Rico)

Purchase Parts, Accessories and Instruction Books online for all Panasonic Products by visiting our Web Site at:

<http://www.pstc.panasonic.com>

Or, send your request by E-mail to:

npcparts@us.panasonic.com

You may also contact us directly at:

1-800-332-5368 (Phone) 1-800-237-9080 (Fax Only)

(Monday-Friday 9am-9pm EST)

Panasonic National Parts Center

20421 84th Avenue South

Kent, WA 98032

(We accept Visa, MasterCard, Discover Card, American Express)

For hearing or speech impaired TTY users, TTY: 1-866-605-1277

As of Feb 2012

Note

Technical Specifications

Model No.		NE-12521 / NE-12523	NE-17521 / NE-17523 NE-17723	NE-21521 / NE-21523	
Power Source		120 V, 60 Hz., single phase		208 V / 230 V, 60 Hz., single phase	
Required Power (Voltage)		16.0 A (120 V)	14.3 A (208 V) 13.3 A (230 V)	16.6 A (208 V) 15.3 A (230 V)	
Receptacle Required		20 AMP NEMA #5-20R	15 AMP NEMA #6-15R 20 AMP NEMA #6-20R	20 AMP NEMA #6-20R	
Output (approx.)	HIGH	(P10)	1200 W*	1700 W*	2100 W*
	MEDIUM HIGH	(P9)	95 %		
		(P8)	85 %		
		(P7)	75 %		
		(P6)	65 %		
	MEDIUM	(P5)	55 %		
		(P4)	45 %		
	LOW	(P3)	35 %		
		(P2)	30 %	25 %	25 %
	DEFROST	(P1)	340 W	340 W	340 W
—		0			
HEAT FROM TOP DOWN	(PU1) (PU2)	50 % 25 %			
HEAT FROM BOTTOM UP	(PL1) (PL2)	50 % 25 %			
Frequency		2450 MHz			
Outer dimensions (W x D x H)		16 ⁵ / ₈ " x 20" x 13 ¹ / ₄ " (422 mm x 508 mm x 337 mm)			
Cavity dimensions (W x D x H)		13" x 12 ⁷ / ₃₂ " x 6 ⁷ / ₈ " (330 mm x 310 mm x 175 mm)			
Net weight (approx.)		56 lbs. (25.5 kg)	61 lbs. (27.5 kg)	65 lbs. (29.5 kg)	

*IEC Test Procedure
Specifications subject to change without notice.

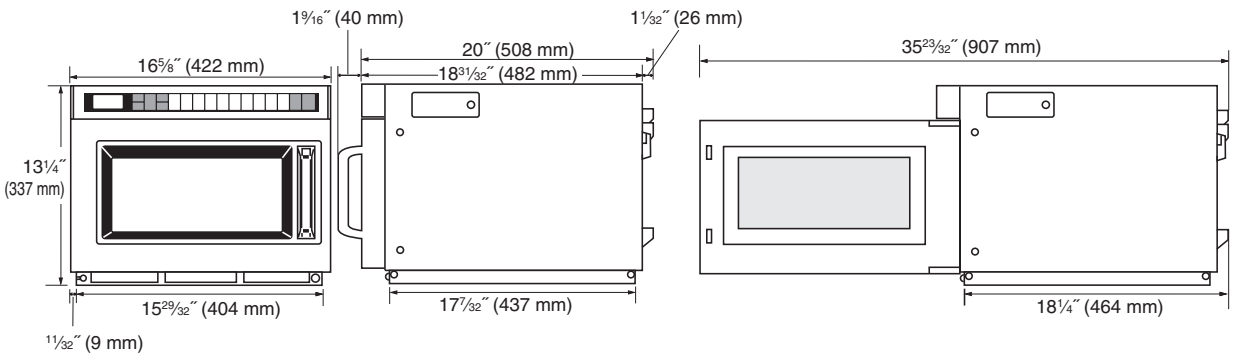

www.panasonic.com/cmo

**Panasonic Consumer Electronics
Company, Division of Panasonic
Corporation of North America**

One Panasonic Way
Secaucus, New Jersey 07094
Or Call (201) 348-5377

© Panasonic Corporation 2012

A00033E80AP
F0612-0
Printed in Japan