



User Manual

Chest Freezer

MODEL: BD155

BD215

BD305

BD450

BD550

BD750

BD950

IMPORTANT SAFEGUARDS

Your safety and the safety of others are very important.

We have provided many important safety messages in this manual and on your appliance. Always read and obey all safety messages.



This is the Safety Alert Symbol. This symbol alerts you to potential hazards that can kill or injure you and others. All safety messages will follow the Safety Alert Symbol and either the words "DANGER", "WARNING" or "CAUTION".



DANGER means that failure to heed this safety statement may result in severe personal injury or death.



WARNING means that failure to heed this safety statement may result in extensive product damage, serious personal injury, or death.



CAUTION means that failure to heed this safety statement may result in minor or moderate personal injury, or property or equipment damage.

Safety messages will alert you to what the potential hazard is, tell you how to reduce the chance of injury, and let you know what can happen if the instructions are not followed.



Before your chest freezer is used, it must be properly positioned and installed as described in this manual, so read the manual carefully. To reduce the risk of fire, electrical shock or injury when using the chest freezer, follow basic precautions, including the following:



- Plug into a grounded 3-prong outlet. Do not remove grounding prong, do not use an adapter, and do not use an extension cord.
- Replace all panels before operating.
- It is recommended that a separate circuit, serving only your chest freezer, be provided. Use receptacles that cannot be turned off by a switch or pull chain.
- Never clean chest freezer parts with flammable fluids. These fumes can create a fire hazard or explosion.
- Do not store or use gasoline or other flammable vapors and liquids in the vicinity of this or any other appliance. The fumes can create a fire hazard or explosion.

- Before proceeding with cleaning and maintenance operations, make sure the power line of the unit is disconnected.
- Do not connect or disconnect the electric plug when your hands are wet.
- Unplug the chest freezer or disconnect the power before cleaning or servicing. Failure to do so can result in electrical shock or death.
- Do not attempt to repair or replace any part of your chest freezer unless it is specifically recommended in this material. All other servicing should be referred to a qualified technician.

WARNING

- **This unit is not designed to operate in enclosed spaces. When placing your unit, make sure you allow adequate airflow on all sides.**
 - Use two or more people to move and install the chest freezer. Failure to do so can result in back or other injury.
 - To ensure proper ventilation for your chest freezer, the front of the unit must be completely unobstructed. Choose a well-ventilated area with temperatures above 55°F (13°C) and below 90°F (32°C). This unit must be installed in an area protected from the elements, such as wind, rain, water spray or sunlight.
 - The chest freezer should not be located next to ovens, grills or other sources of high heat.
 - The chest freezer must be installed with all electrical connections in accordance with state and local codes. A standard electrical supply (115V AC, 60 Hz), properly grounded in accordance with the National Electrical Code and local codes and ordinances, is required.
 - Do not kink or pinch the power supply cord of the chest freezer.
 - The fuse (or dedicated circuit breaker) size should be 15 amperes.
 - It is important for the chest freezer to be leveled in order to work properly. You may need to make several adjustments to level it.
 - Never allow children to operate, play with or crawl inside the chest freezer
 - Do not use solvent-based cleaning agents or abrasives on the interior. These cleaners may damage or discolor the interior.
 - Keep fingers out of the “pinch point” areas. Clearances between the door and cabinet are necessarily small. Be careful closing door when children are in the area.
 - Do not use this apparatus for other than its intended purpose.
-

DANGER

Risk of child entrapment

Child entrapment and suffocation are not problems of the past. Junked or abandoned freezers are still dangerous, even if they will “just sit in the garage a few days.”

- **Before you throw away your old freezer:** Take off the doors. Leave the shelves in place so that children may not easily climb inside.
- Never allow children to operate, play with, or crawl inside the freezer.

- SAVE THESE INSTRUCTIONS -

Installation Instructions

Before Using Your Freezer

- Remove the exterior and interior packing.
- Check to be sure you have all of the following parts:
 - 1 or more storage baskets
 - 1 instruction manual
- Before connecting the freezer to the power source, let it stand upright for approximately 2 hours. This will reduce the possibility of a malfunction in the cooling system from handling during transportation.
- Clean the interior surface with lukewarm water using a soft cloth.

Installing Your Freezer

- This appliance is designed to be free standing only, and should not be recessed or built-in.
- Place your freezer on a floor that is strong enough to support the freezer when it is fully loaded.
- Allow 5 inches of space at the back and sides of the freezer, which allows proper air circulation.
- Be sure the freezer is absolutely level for proper operation. Check with a carpenter's level. Place thin wood or metal shims under the freezer if necessary.
- Locate the freezer away from direct sunlight and sources of heat (stove, heater, radiator, etc.). Direct sunlight may affect the acrylic coating and heat sources may increase electrical consumption. Extremely cold ambient temperatures may also cause the freezer not to perform properly.
- Avoid locating the freezer in moist areas.
- Plug the freezer into an exclusive, properly installed, grounded wall outlet. Do not under any circumstances cut or remove the third (ground) prong from the power cord. Any questions concerning power and/or grounding should be directed toward a certified electrician or an authorized service center.
- After plugging the appliance into a wall outlet, allow the unit to cool down for at least 4 hours before placing food in the freezer.

Electrical Connection

WARNING

Improper use of the grounded plug can result in the risk of electrical shock. If the power cord is damaged, have it replaced by an authorized service center.

This freezer should be properly grounded for your safety. The power cord is equipped with a three-prong plug that mates with standard three-prong wall outlets to minimize the possibility of electrical shock.

Do not under any circumstances cut or remove the third (ground) prong from the power cord supplied.

This freezer requires a standard 115Volt / 60Hz electrical outlet with three-prong ground.

To prevent accidental injury, the cord should be secured behind the freezer and not left exposed or dangling.

Never unplug the freezer by pulling the power cord. Always grip the plug firmly and pull straight out from the receptacle. Never handle the cord with wet hands.

Do not use an extension cord with this appliance. If the power cord is too short, have a qualified electrician or service technician install an outlet near the appliance.

A green **Power** light indicates that the freezer is properly connected to the electrical power. The light indicates that power is supplied, and will glow even if the temperature control dial is turned to "0", or the compressor has failed to work and the compartment is not being cooled.

A red **Alarm** light will also turn on when the unit is plugged in, and will stay on until the temperature inside falls below -11°C (12.2°F). As a warning, it will turn on again if the interior temperature rises above -11°C.

Operating Your Freezer

Temperature Control



- The settings of the temperature control are "1 (warmest), 2, 3, 4, 5, 6, 7 (coldest)" Adjust the temperature control to the setting that best suits your needs.
- Turning the temperature to "0" position will shut off the cooling cycle, but does not turn off the electrical power to the unit.
- Unplug the unit to shut off the power to the unit.

Note: If the temperature control knob sets to 7, the compressor may run continuously. It's a quick-frozen mode. Please do not set to 7 frequently.

NOTES:

- ✓ If the unit is unplugged, has lost power or is turned off, you must wait 3 to 5 minutes before restarting the unit. If you attempt to restart before this time delay, the freezer will not start.
- ✓ Adding large amounts of room-temperature food at one time will temporarily lower the cooling efficiency of the appliance.
- ✓ If you choose to change the thermostat setting, adjust the temperature control by one numerical increment at a time. Allow several hours for temperature to stabilize

between adjustments.

- ✓ When loading the freezer, freeze only three pounds of fresh food per cubic foot of freezer space at one time.
- ✓ Distribute packages to be frozen evenly throughout the freezer.
- ✓ The freezer door is susceptible to breaking due to excessive ice buildup. Be sure to defrost when the ice reaches $\frac{1}{4}$ to $\frac{1}{2}$ inch thickness.

Defrosting Your Freezer

- For the most efficient operation and minimum energy consumption, defrost the freezer when the frost on the freezer walls is excessive or $\frac{1}{4}$ to $\frac{1}{2}$ inch thick.
- Choose a time when the stock of frozen food is low.

CAUTION

Do not use boiling water because it may damage the plastic parts. In addition, never use a sharp or metallic instrument to remove frost as it may damage the cooling coils and will void the warranty. We recommend using a plastic scraper.

To defrost,

1. Remove the frozen food from the freezer and place it in another cooling device to protect the food.
2. Turn the thermostat knob to “0”.
3. Unplug the freezer. The **Power** light will go off.
4. Remove the drain plug on the floor of the freezer by pulling straight out. During defrosting, the ice melts into the cabinet. Leave the door open.
5. Place a shallow pan outside the drain outlet. The defrost water will drain out.
6. Check the pan occasionally so the water does not overflow.
7. Clean and thoroughly dry the interior of the freezer.
8. Replace the plug on the inside floor.
9. Close the door and plug in the freezer.
10. Reset the thermostat to the desired setting.
11. Allow several hours for the cabinet to cool down.
12. Return food to the freezer, wiping off packages if they are covered with moisture.

HELPFUL HINTS:

Defrosting usually takes a few hours. Leaving the door open will help speed the process. Also, pouring warm water (not boiling) on the ice/frost will speed melting. If you must use a scraper, it should be plastic and not wood or metal. Use caution: it is very easy to damage the freezer compartment and void your warranty.

Care of Frozen Food

- The freezer is designed for the long-term storage of frozen food. Storage time is generally up to three months.
- The storage life of frozen foods varies and the recommended storage time should not be exceeded. Instructions regarding the care of frozen foods should be followed

when defrosting the freezer.

- Pre-packed commercially frozen food should be stored in accordance with the frozen food manufacturer's instructions for a three star frozen food storage compartment or home freezer.
- Place frozen food into the freezer as quickly as possible after purchase. If there are instructions on the packet, carefully follow these instructions regarding storage times.
- At least one storage basket is provided for the organization of odd-shaped items. (Larger models have more than one basket.) To reach other packages in the freezer, just slide the basket to one side, or lift it out.

Care and Maintenance

Cleaning Your Freezer

- Upon installation of your new appliance, we recommend that it be cleaned thoroughly.
- Turn the thermostat knob to "**OFF**", unplug the freezer, remove the food and storage basket(s).
- Wash the inside with a damp warm cloth moistened with a water and baking soda solution. (Dissolve 2 tablespoons of baking soda in a quart of water.)
- Wash the storage basket with a mild detergent solution.
- To keep the unit running efficiently, be sure to keep the door gasket (seal) clean.
- The outside of the freezer should be cleaned with mild detergent and warm water.
- Dry the interior and exterior with a soft cloth.
- The condenser coils at the back should be vacuumed when they are dusty or dirty.
- It is recommended that the unit be cleaned each time it is defrosted to help keep the unit odor-free and running efficiently.

Vacations

- **Short vacations:** Leave the freezer operating during vacations of less than three weeks.
- **Long vacations:** If the appliance will not be used for several months, remove all food and unplug the power cord. Clean and dry the interior thoroughly. To prevent odor and mold growth, leave the door open slightly, blocking it open if necessary, or have the door removed. Use extreme caution in the case of children. The unit should not be accessible to children at play.

Power Failure

NOTE: Do not open freezer door unnecessarily if freezer is off for several hours.

If a power failure occurs, frozen foods will stay frozen for at least 24 hours if the freezer is kept closed. If the power failure continues, pack seven or eight pounds of dry ice into the freezer every 24 hours. Look in the Yellow Pages under *Dry Ice, Dairies, or Ice Cream Manufacturers* for local dry ice suppliers. Always wear gloves and use caution when handling dry ice.

Moving Your Freezer

- Remove all the food.
- Securely tape down all loose items inside the freezer.
- Tape the door shut.
- Be sure the freezer stays in the upright position during transport.

Energy-Saving Tips

- The freezer should be located in the coolest area of the room, away from heat-producing appliances or heating ducts, and out of direct sunlight.
- Let hot foods cool to room temperature before placing in the freezer. Overloading the freezer forces the compressor to run longer. Foods that freeze too slowly may lose quality, or spoil.
- Be sure to wrap foods properly, and wipe containers dry before placing them in the freezer. This cuts down on frost build-up inside the freezer.
- The freezer's storage bin or baskets should not be lined with aluminum foil, wax paper or paper toweling. Liners interfere with cold air circulation, making the freezer less efficient.
- Organize and label food to reduce door openings and extended searches. Remove as many items as needed at one time, and close the door as soon as possible.

Problems with your freezer

You can solve many common freezer problems easily, saving you the cost of a possible service call. Try the suggestions below to see if you can solve the problem before calling the service agent.

TROUBLESHOOTING GUIDE

Problem	Possible Causes
Freezer does not operate.	Not plugged in. Circuit breaker tripped or fuse blown. The thermostat knob is at "0".
Compressor turns on and off frequently.	The room temperature is warmer than usual. A large amount of food has been added to the freezer. The door is opened too often. The door is not closed completely. The temperature control is not set correctly. The door gasket does not seal properly. The freezer does not have the correct clearances. The freezer has recently been disconnected for a period of time. Four hours are required for the freezer to cool down completely.
Temperature inside the freezer is too warm.	Temperature control is set too warm. Turn the control to a cooler setting and allow several hours for the temperature to stabilize. Door is kept open too long or is opened too frequently. Warm air enters the freezer every time the door is opened. Open the door less often. The door is not closed completely. The door gasket does not seal properly. A large amount of warm or hot food might have been stored recently. Wait until the freezer has had a chance to reach its selected temperature. The freezer has recently been disconnected for a period of time. Four hours are required for the freezer to cool down completely.
Temperature inside the freezer is too cold.	Temperature control is set too cold. Turn the control to a warmer setting and allow several hours for the temperature to stabilize.
Temperature of external freezer surface is warm.	The exterior freezer walls can be as much as 30°F warmer than room temperature. This is normal while the compressor works to transfer heat from inside the freezer cabinet.

Vibrations	<p>Check to be sure the freezer is level.</p> <p>Floor is uneven or weak. Freezer rocks on the floor when it is moved slightly. Be sure floor can adequately support freezer. Level the freezer by putting wood or metal shims under part of the freezer.</p> <p>The freezer is touching the wall. Move it from the wall and re-level the freezer.</p> <p>See <i>Installation Instructions</i>.</p>
The door will not close properly.	<p>The freezer is not on a level surface.</p> <p>The gasket is dirty.</p> <p>The storage basket is out of position.</p>

 **WARNING:** This product can expose you to chemicals including Nickel (Metallic) which is known to the State of California to cause cancer, birth defects or other reproductive harm.

For more information go to www.P65Warnings.ca.gov

Note: Nickel is a component in all stainless steel and some other metallic compositions.

Support Number 1-888-585-9440

	BD155	BD215
In: Product External Dimensions W x D X H	28.94 x 23.23 x 33.46	35.24 x 23.23 x 33.46
mm: Product External Dimensions W x D X H	735 x 590 x 850	895 x 590 x 850
Capacity	5.4 Cu Ft / 152 L	7 Cu Ft / 197 L
Manual Defrost	Yes	Yes
Voltage / Frequency	115V/60Hz	115V/60Hz
HP	0.09	0.1
Temperature Range F°/C°	-10° to 10° F -23° to -12° C	-10° to 10° F -23° to -12° C
Factory Temperature Setting	0°F (-17.8°C)	0°F (-17.8°C)
Unit Weight	61.7 lbs (28 kg)	69.4 lbs (31.5 kg)
Shipping Weight	68.3 lbs (31 kg)	77.2 lbs (35 kg)

	BD305	BD450
In: Product External Dimensions W x D X H	44.29 x 23.23 x 33.46	50.20 x 29.53 x 33.46
mm: Product External Dimensions W x D X H	1125 x 590 x 850	1275 x 750 x 850
Capacity	8.9 Cu Ft / 252 L	13.0 Cu Ft / 368 L
Manual Defrost	Yes	Yes
Voltage / Frequency	115V/60Hz	115V/60Hz
HP	0.11	0.11
Temperature Range F°/C°	-10° to 10° F -23° to -12° C	-10° to 10° F -23° to -12° C
Factory Temperature Setting	0°F (-17.8°C)	0°F (-17.8°C)
Unit Weight	83.8 lbs (38 kg)	110.2 lbs (50 kg)
Shipping Weight	94.8 lbs (43 kg)	123.5 lbs (56 kg)

	BD550	BD750
In: Product External Dimensions W x D X H	60.43 x 29.53 x 33.46	81.69 x 29.53 x 33.46
mm: Product External Dimensions W x D X H	1535 x 750 x 850	2075 x 750 x 850
Capacity	16.2 Cu Ft / 459 L	23.7 Cu Ft / 670 L
Manual Defrost	Yes	Yes
Voltage / Frequency	115V/60Hz	115V/60Hz
HP	0.16	0.21
Temperature Range F°/C°	-10° to 10° F -23° to -12° C	-10° to 10° F -23° to -12° C
Factory Temperature Setting	0°F (-17.8°C)	0°F (-17.8°C)
Unit Weight	125.7 lbs (57 kg)	166.4 lbs (75.5 kg)
Shipping Weight	141.1 lbs (64 kg)	183.0 lbs (83 kg)

	BD950
In: Product External Dimensions W x D X H	79.92 x 35.83 x 37.40
mm: Product External Dimensions W x D X H	2030 x 910 x 950
Capacity	30.6 Cu Ft / 867 L
Manual Defrost	Yes
Voltage / Frequency	115V/60Hz
HP	0.26
Temperature Range F°/C°	-10° to 10° F -23° to -12° C
Factory Temperature Setting	0°F (-17.8°C)
Unit Weight	194 lbs (88 kg)
Shipping Weight	254 lbs (115 kg)

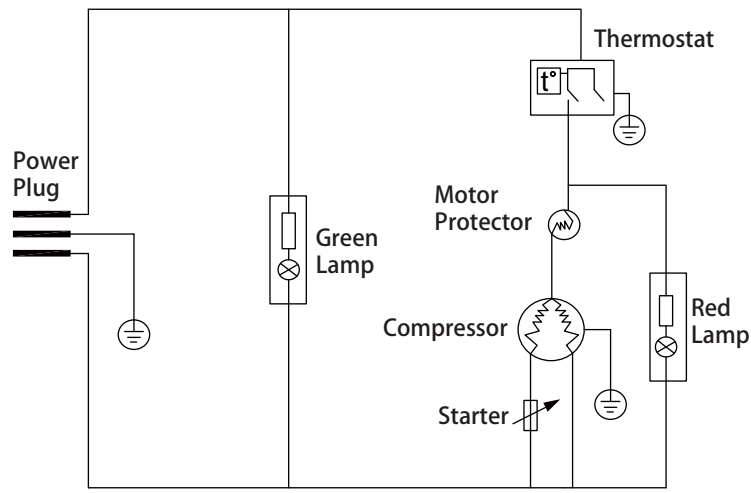

BD155/BD215

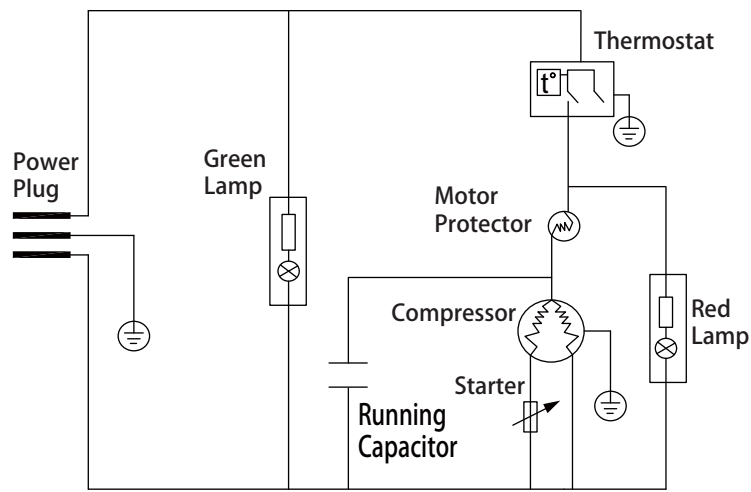

BD305/BD450/BD550

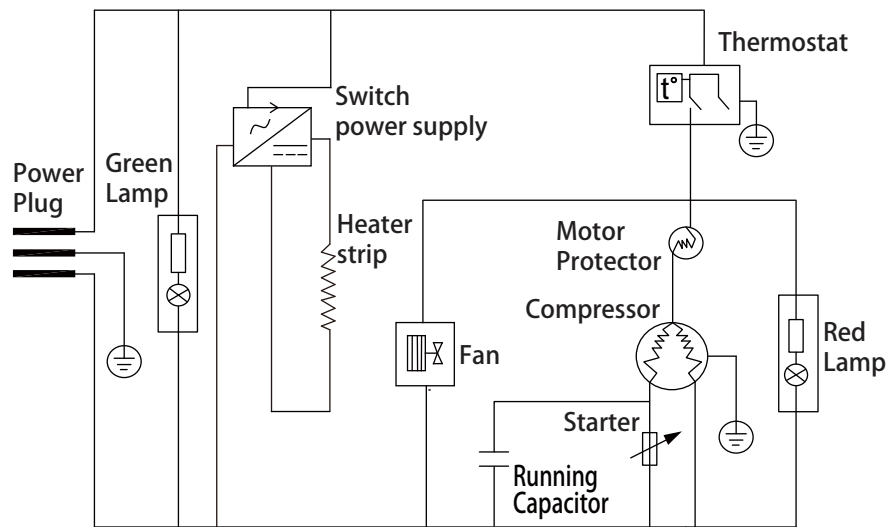

BD750/BD950



Berg Chest Freezer Warranty

1 Year Limited Replacement Warranty - Valid Only in the Continental United States for Berg Chest Freezers Only

Berg Chest Freezer, warrants to the original purchaser of new, qualified Berg Chest Freezers, that such equipment will be free from defects in materials and workmanship for a period of 1 year from the date of delivery. A copy of the original receipt or other proof of purchase must be submitted and verified to obtain warranty coverage. This warranty applies to the original owner only and is not assignable.

If a Berg Chest Freezer is found to be defective during this period, Berg Chest Freezers will repair the defective unit, replace any defective parts, or replace the defective unit.

Exclusions

The warranty described herein does not cover the following:

- 1) The original serial number has been removed, altered or cannot be readily determined on the Berg Chest Freezer
- 2) Normal wear and tear and gradual deterioration on the Berg Chest Freezer.
- 3) When the Berg Chest Freezer has been transferred from an original owner to another party.
- 4) When the Berg Chest Freezer has been moved outside of the continental United States.
- 5) Rust on the interior or exterior of the Berg Chest Freezer.
- 6) When a Berg Chest Freezer is purchased "as is."
- 7) When the Berg Chest Freezer is defective, but the defect does not involve malfunction or defects in materials or workmanship.
- 8) When the Berg Chest Freezer is used in way that is not in accordance with provided instructions and intended purpose.
- 9) When the Berg Chest Freezer is installed in places other than recommended locations, including, but not limited to, outside, open air venues, and residential locations.
- 10) Expenses for making the defective Berg Chest Freezer available for removal or accessible for the replacement Berg Chest Freezer, such as removing shelves, etc.
- 11) Common wear and tear items, including, but not limited to, light bulbs, air filters, water filters, knobs, handles, gaskets, power cords, and other cosmetic parts.
- 12) Damages to the finish of the Berg Chest Freezer that occur during installation.
- 13) When the Berg Chest Freezer has been repaired, modified or altered by the owner or a third party.

- 14) Damage to the Berg Chest Freezer as a result of misuse, abuse, neglect, accidents, fire, flooding, or acts of God.
- 15) Damage to the Berg Chest Freezer relating to improper utility connection or supply and problems due to improper ventilations.
- 16) Damage to the contents being stored in the malfunctioning Berg Chest Freezer.

THE FOREGOING WARRANTY IS EXCLUSIVE AND IS IN LIEU OF ANY OTHER WARRANTY, WRITTEN OR ORAL EXPRESS OR IMPLIED, INCLUDING, BUT NOT LIMITED TO, ANY IMPLIED WARRANTY OF EITHER MERCHANTABILITY OR FITNESS FOR A PARTICULAR PURPOSE.

The agents, employees, distributors, and dealers of Berg Chest Freezers are not authorized to make modifications to this warranty or to make additional warranties that are binding on Berg Chest Freezers. Accordingly, statements by such individuals, whether oral or written, do not constitute warranties and should not be relied upon.

THE BUYER'S REMEDY AGAINST BERG CHEST FREEZERS, FOR THE BREACH OF ANY OBLIGATION ARISING OUT OF THE SALE OF A BERG CHEST FREEZER, WHETHER DERIVED FROM WARRANTY OR OTHERWISE, SHALL BE LIMITED TO REPLACEMENT OF THE BERG CHEST FREEZER.

In no event shall Berg Chest Freezers. be liable for any other damage or loss, including, but not limited to, lost profits, lost sales, loss of use of equipment, claims of Buyer's customers, cost of interruption or down time, cost of substitute equipment, facilities, or services, or any other special, incidental, or consequential damages.

To Obtain Warranty Service, call 888-585-9440