



GAS

PRO SERIES | 48" RANGES

IMPERIAL



IR-8

Shown with optional casters

STANDARD OVENS

- Both Space Saver and Chef Depth (XB) ovens are available.
- Linear burner provides even heating throughout the oven.
- Space Saver output is 27,000 BTU (8KW), Chef Depth is 35,000 BTU (10 KW).
- Unique burner baffle distributes heat flow to provide even temperatures throughout the oven cavity.
- Exclusive heat deflector reflects heat into the oven, not the floor. 100% safety pilot.
- Space Saver interior is 20" w x 26" d x 14" h (508 w x 660 d x 356 h mm). Chef Depth interior is 26-1/2" w x 26" d x 14" h (673 w x 660 d x 356 h mm) and accommodates 18" x 26" (457 x 660 mm) sheet pans left-to-right and front-to-back.
- Porcelainized sides, rear, deck and door lining for easy cleaning. Heavy duty door hinge.
- Stamped inner door liner provides extra strength while optimizing heat retention.
- One chrome oven rack is included.

CONVECTION OVENS

- 30,000 BTU/hr. (9 KW) convection oven with 1/2 hp blower motor cooks products quickly and evenly with less shrinkage.
- Convection oven interior dimensions 26-1/2" w x 22-1/2" d x 14" h (673 x 572 x 356 mm).
- Three position switch for cooking or cool down. Fan shuts off automatically when door is open.
- Porcelainized sides, rear, deck and door lining for easy cleaning. Heavy duty door hinge.
- Three chrome oven racks are included.
- Electronic ignition system with electronic timer countdown.

Crated Dimensions:

50-1/2" w x 39" d x 35" h (1283 x 991 x 889 mm)

Dimensions:

48" w x 31-1/2" d x 56-1/2" h (1219 x 800 x 1435 mm)

Model Numbers

IR-2-G36	IR-4-G24	IR-4-RG24
IR-2-G36-XB	IR-4-G24-XB	IR-4-RG24-XB
IR-2-G36-C-XB	IR-4-G24-C-XB	IR-4-RG24-C-XB
IR-6-G12	IR-8	IR-G48
IR-6-G12-XB	IR-8-XB	IR-G48-XB
IR-6-G12-C-XB	IR-8-C-XB	IR-G48-C-XB

OPEN BURNERS



ROUND STAINLESS STEEL "CHEFS" HANDLE

- PyroCentric™ 32,000 BTU (9 KW) anti-clogging burner with a 7,000 BTU/hr. (2 KW) low simmer feature. Two rings of flame for even heating.
- Cast iron PyroCentric burners are standard on all IR Series Ranges.
- Burners are anti-clogging and lift-off and separate for easy cleaning. No gaskets or screws.
- One standing pilot per burner for instant ignition.

GRATES



NEW TWO PIECE TOP GRATE DESIGN

- Front grates measure 12" x 12" (305 x 279 mm). Back grates are 12" x 13" (305 x 330 mm).
- Back grates are sized for positioning large stock pots directly over burner and feature a hot air dam.
- Pots slide easily from section to section and onto landing ledge.
- Grates are cast iron for a long service life.
- All stainless steel upper burner box, top grate supports front and rear.

GRIDDLE/RAISED GRIDDLE OPTIONS

- Highly polished 3/4" (19 mm) steel plate. 21" (533 mm) plate depth.
- Burners have 20,000 (6 KW) BTU/hr. output with a heat deflector every 12" (305) for even heating.
- 3" (76 mm) wide grease trough and removable grease can for easy cleaning.
- Large griddle grease can and full width broiler drip tray are removable for easy cleaning.

Notes:

"C-XB" specifies (1) 26-1/2" (673 mm) Convection Oven and (1) Cabinet Base

"XB" specifies Cabinet Base model

"G" specifies Griddle Top

"RG" specifies Raised Griddle/Broiler Top

Measurements in () are metric equivalents.





GAS

PRO SERIES | 48" RANGES

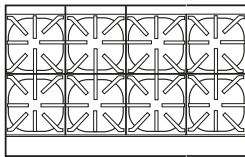
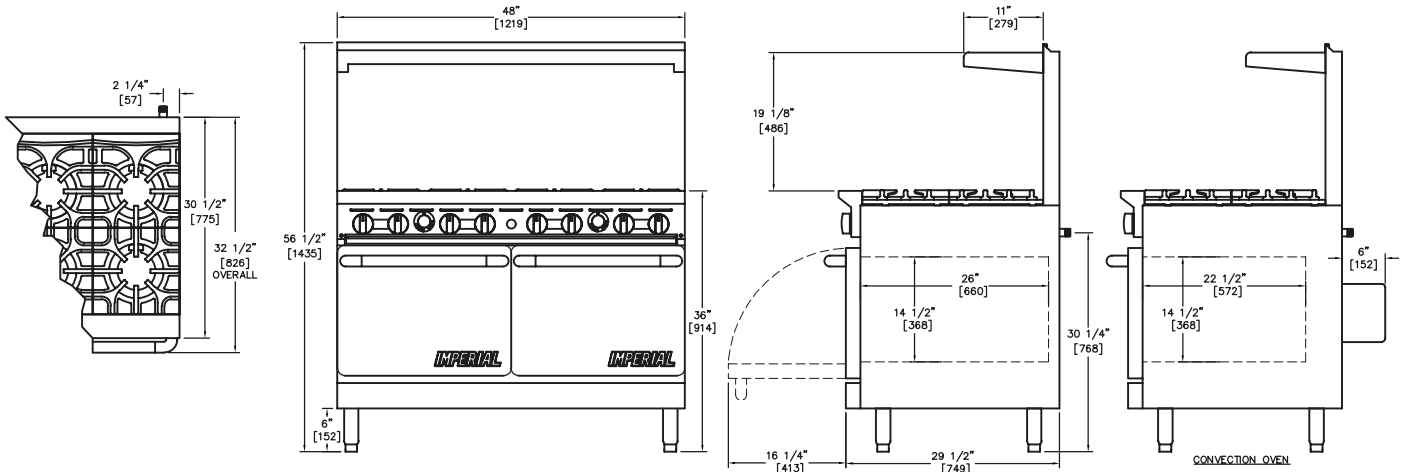

MODEL	GAS OUTPUT		OPEN BURNERS	GRIDDLE WIDTH	SHIP WEIGHT	
	BTU	KW			KG	LBS
IR-8	310,000	91	8	N/A	322	715
IR-8-C-XB	286,000	84	8	N/A	303	670
IR-8-XB	291,000	85	8	N/A	290	640

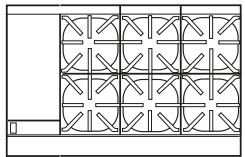

MODEL	GAS OUTPUT		OPEN BURNERS	GRIDDLE WIDTH	SHIP WEIGHT	
	BTU	KW			KG	LBS
IR-6-G12	266,000	78	6	12" (305 MM)	344	760
IR-6-G12-C-XB	242,000	71	6	12" (305 MM)	326	720
IR-6-G12-XB	247,000	72	6	12" (305 MM)	312	690

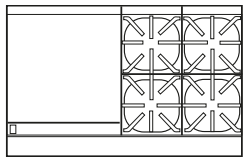

MODEL	GAS OUTPUT		OPEN BURNERS	GRIDDLE WIDTH	SHIP WEIGHT	
	BTU	KW			KG	LBS
IR-4-G24	222,000	65	4	24" (610 MM)	367	810
IR-4-G24-C-XB	198,000	58	4	24" (610 MM)	348	770
IR-4-G24-XB	203,000	59	4	24" (610 MM)	335	740

RAISED GRIDDLE

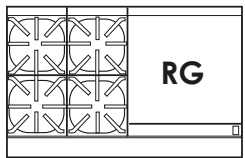

MODEL	GAS OUTPUT		OPEN BURNERS	GRIDDLE WIDTH	SHIP WEIGHT	
	BTU	KW			KG	LBS
IR-4-RG24	222,000	65	4	24" (610 MM)	385	850
IR-4-RG24-XB	203,000	59	4	24" (610 MM)	353	780
IR-4-RG24-C-XB	198,000	58	4	24" (610 MM)	367	810

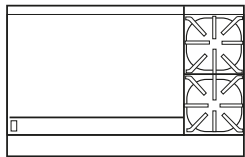

MODEL	GAS OUTPUT		OPEN BURNERS	GRIDDLE WIDTH	SHIP WEIGHT	
	BTU	KW			KG	LBS
IR-2-G36	178,000	52	2	36" (914 MM)	385	850
IR-2-G36-C-XB	154,000	45	2	36" (914 MM)	367	810
IR-2-G36-XB	159,000	47	2	36" (914 MM)	353	780

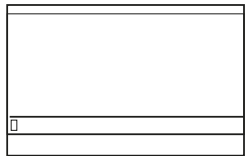

MODEL	GAS OUTPUT		OPEN BURNERS	GRIDDLE WIDTH	SHIP WEIGHT	
	BTU	KW			KG	LBS
IR-G48	134,000	39	N/A	48" (1219 MM)	394	870
IR-G48-C-XB	110,000	32	N/A	48" (1219 MM)	376	830
IR-G48-XB	115,000	34	N/A	48" (1219 MM)	361	800

EXTERIOR

- Stainless steel front, sides, backguard, shelf, landing ledge and kick plate
- Welded and polished stainless steel seams
- Large 3.5" (127 mm) stainless steel landing ledge
- Control knobs are durable cast aluminum.
- Full width, removable crumb tray under open burners for easy cleaning
- 6" (152 mm) heavy duty legs with adjustable feet
- One year parts and labor warranty

OPTIONS AND ACCESSORIES

- Reinforcement channels for mounting cheese melter and salamander
- 6" and 11" (152 and 279 mm) stainless steel backguards. Stubbyback available
- 10" (254 mm) stainless steel wok ring
- Saute burner head, interchangeable
- Wok burner head, interchangeable
- 220V motor and transformer for convection oven
- Extra oven racks
- Thermostatic griddle control
- Grooved griddle plate
- Chrome griddle plate
- Griddle safety valve
- Gas shut off valve 3/4" (19 mm)
- Quick disconnect and flexible gas hose
- 6" (152 mm) casters

CLEARANCE REQUIREMENTS

For use only on non-combustible floors. Legs or casters are required for non-combustible floors; or 2" (51 mm) overhang is required when curb mounted. Provide 0" clearance from non-combustible surfaces and 8" (203 mm) from combustible surfaces.

MANIFOLD PRESSURE		
NATURAL GAS	PROPANE GAS	MANIFOLD SIZE
5.0" W.C.	10.0" W.C.	3/4" (19 MM)

CONVECTION OVEN ELECTRICAL REQUIREMENT		
VOLTAGE	PHASE	AMPS
120	1	6