

Model Number

IFSCB150E	IFSCB150EU
IFSCB250E	IFSCB250EU
IFSCB350E	IFSCB350EU
IFSCB450E	IFSCB450EU
IFSCB550E	IFSCB550EU
IFSCB650E	IFSCB650EU

Add suffix "T" for Electronic Thermostat

Add suffix "C" for Computer Controls

Suffix "E" denotes Immersed Elements

Suffix "EU" denotes Tilt-up Elements

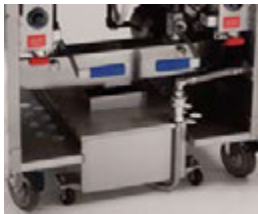

Filter is located under fryers to save valuable space.



Filter pan is designed for maximum oil return.



5.5 GPM, 1/3 HP roller pump speeds up filtering process.



Side Car includes a stainless steel cabinet with a drain area, food warmer and dump pan.



IFSCB250EU

FILTER PACKAGE CHOICES - Up to six fryers can be battered into one fryer / filter system.

- Available for 50 and 75 lb. (27 and 41 Liters) oil capacity fryers.
- Available with Snap Action Thermostats, Electronic Thermostats or Computer Controls

LOCATED UNDER FRYERS - Filter location under fryers saves valuable space.

- Internally plumbed oil drain and return line.

UNIQUE FILTER PAN DESIGN - Filter pan is designed for maximum oil return.

- Stainless steel construction is easy to clean and has a professional look.
- Positive-latching filter paper holder holds paper in place for optimal filtration.
- Quick disconnect connection offers quick and safe connection of the filtered oil back into the frypots.
- All oil drain and return lines are internally plumbed for convenience and safety.

ROLLER-PUMP - Up to six fryers can be battered into one fryer / filter system.

- 5.5 GPM pump with a 1/3 HP motor speeds up filtering process.
- Can pump oil into a disposal vat up to 20 feet away.

DRAIN STATION - Includes a matching stainless steel cabinet with a food warmer and dump pan.

- Cabinet may be located anywhere within the fryer battery.
- Cabinet is a convenient storage area when located at the end of the battery.

EXTERIOR FEATURES - Continuous cabinet provides a professional look.

- 5" (127 mm) deep continuous stainless steel front landing ledge.
- Stainless steel precision welded frypot.
- Includes casters, joiner strips and filter starter kit.



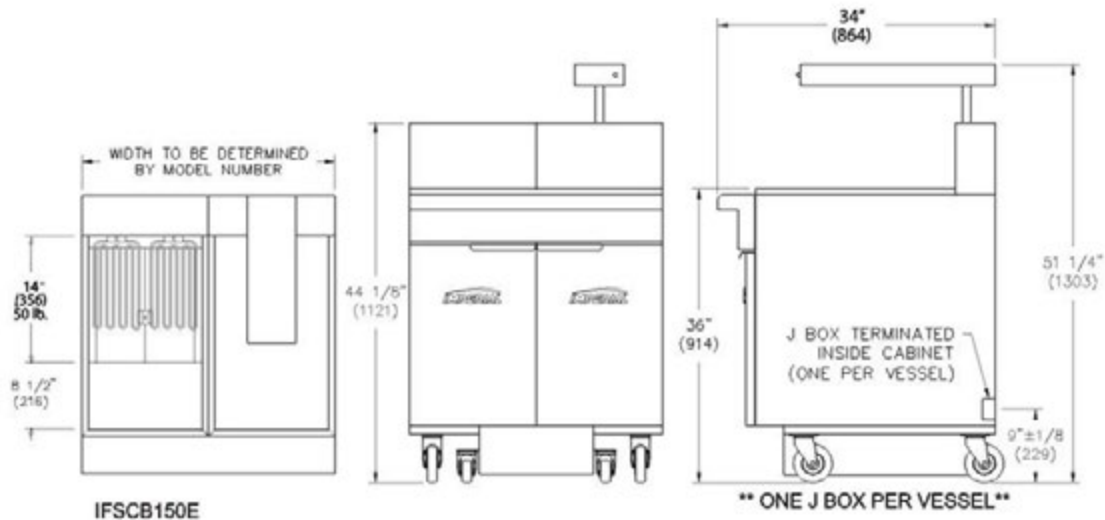

MODEL	FRYER OIL CAPACITY	OVERALL WIDTH	NUMBER OF FRYERS	SHIP WEIGHT (KG)	LBS
IFSCB150E	50 lbs. (41 L)	31" (787 mm)	1	(196)	433
IFSCB250E	50 lbs. (41 L)	46-1/2" (1181 mm)	2	(311)	626
IFSCB350E	50 lbs. (41 L)	62" (1575 mm)	3	(426)	393
IFSCB450E	50 lbs. (41 L)	77-1/2" (1969 mm)	4	(541)	1,092
IFSCB550E	50 lbs. (41 L)	93" (2362 mm)	5	(655)	1445
IFSCB650E	50 lbs. (41 L)	108-1/2" (2756 mm)	6	(770)	1698

Measurements in () are metric equivalents.

MODEL	DIMENSIONS	CRATED DIMENSIONS
IFSCB150E	31" w x 34" d x 44-1/8" h (787 x 864 x 1121 mm)	32-1/2" w x 39" d x 49-1/2" h (826 x 991 x 1257 mm)
IFSCB250E	46-1/2" w x 34" d x 44-1/8" h (1181 x 864 x 1121 mm)	48" w x 39" d x 49-1/2" h (1219 x 991 x 1257 mm)
IFSCB350E	62" w x 34" d x 44-1/8" h (1575 x 864 x 1121 mm)	63-1/2" w x 39" d x 49-1/2" h (1613 x 991 x 1257 mm)
IFSCB450E	77-1/2" w x 34" d x 44-1/8" h (1969 x 864 x 1121 mm)	79" w x 39" d x 49-1/2" h (2007 x 991 x 1257 mm)
IFSCB550E	93" w x 34" d x 44-1/8" h (2362 x 864 x 1121 mm)	94-1/2" w x 39" d x 49-1/2" h (2400 x 991 x 1257 mm)
IFSCB650E	108-1/2" w x 34" d x 44-1/8" h (2756 x 864 x 1121 mm)	110" w x 39" d x 49-1/2" h (2794 x 991 x 1257 mm)

FILTER ELECTRICAL REQUIREMENT			
VOLTS	PHASE	HERTZ	AMPS
115 V	1	60	6.8 amps

ELECTRICAL REQUIREMENT PER FRYER				
MODEL	VOLTS	PHASE	HERTZ	AMPS
50 lbs.	208	3	60	42.38
50 lbs.	240	3	60	36.73
50 lbs.	480*	3	60	18.36

* For export only

CLEARANCE REQUIREMENTS

For use only on non-combustible floors. Legs or casters are required for non-combustible floors. Provide 0" clearance from non-combustible surfaces and 6" (152 mm) from combustible surfaces.

OPTIONS AND ACCESSORIES

- Automatic basket lifts with computerized controls
- Manual controlled basket lifts
- Stainless steel tank cover
- Stainless steel side drain shelf
- Stainless steel side splash
- Manual timer
- Filter paper 40# thickness, 20 microns, 100 sheets per box

