



T&S BRASS AND BRONZE WORKS, INC.
 2 Saddleback Cove / P.O. Box 1088
 Travelers Rest, SC 29690

Model No.
B-0543

Item No.

Travelers Rest, SC: 800-476-4103 • Simi Valley, CA: 800-423-0150 • Fax: 864-834-3518 • www.tsbrass.com

This Space for Architect/Engineer Approval

Job Name _____ Date _____

Model Specified _____ Quantity _____

Customer/Wholesaler _____

Contractor _____

Architect/Engineer _____

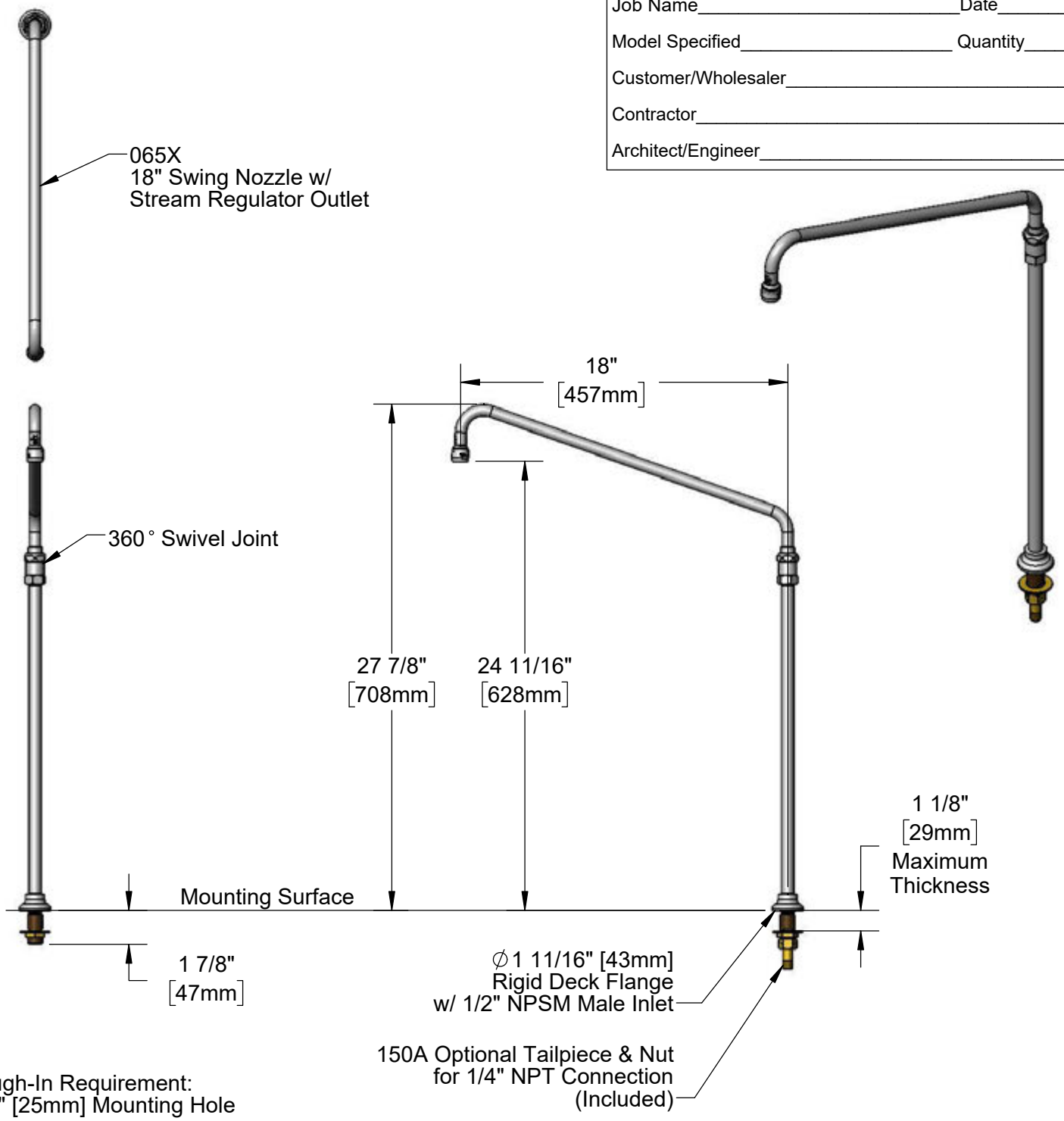

Rough-In Requirement:
 Ø 1" [25mm] Mounting Hole

Product Specifications:

Swivel Deck Mount Dummy, 18" Swing Nozzle, Swivel Piece, Stream Regulator Outlet & 1/2" NPSM Male Inlet

Product Compliance:

ASME A112.18.1 / CSA B125.1
 NSF 61 - Section 9
 NSF 372 (Low Lead Content)



T&S BRASS AND BRONZE WORKS, INC.
 2 Saddleback Cove / P.O. Box 1088
 Travelers Rest, SC 29690

Model No.
B-0543

Item No.

Travelers Rest, SC: 800-476-4103 • Simi Valley, CA: 800-423-0150 • Fax: 864-834-3518 • www.tsbrass.com

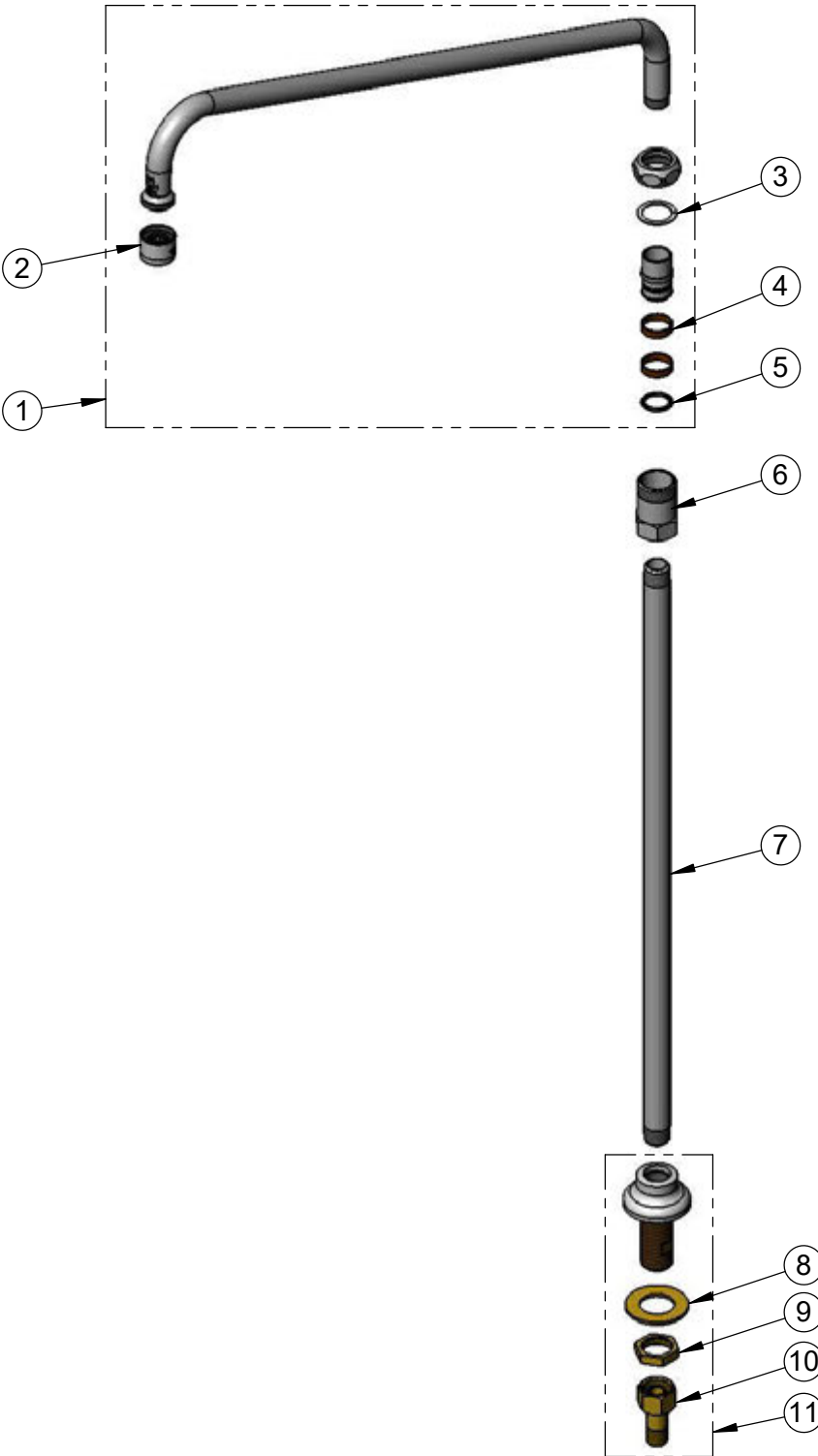

ITEM NO.	SALES NO.	DESCRIPTION
1	065X	18" Swing Nozzle
2	B-PT	Stream Regulator Outlet
3	009538-45	Swivel Washer
4	011429-45	Swivel Sleeves (2)
5	001074-45	O-Ring
6	054X	Swivel Body
7	000369-40	3/8" NPT x 18" Riser
8	000999-45	Brass Lock Washer
9	002954-45	Shank Lock Nut
10	000958-20	Coupling Nut
11	B-0430	Rigid Base Flange

Product Specifications:
 Swivel Deck Mount Dummy, 18" Swing Nozzle, Swivel Piece, Stream Regulator Outlet & 1/2" NPSM Male Inlet

Product Compliance:
 ASME A112.18.1 / CSA B125.1
 NSF 61 - Section 9
 NSF 372 (Low Lead Content)