



**"WE MAKE THE KITCHEN BETTER!"**

Toll Free: 855-855-0399 Email: [info@atosausa.com](mailto:info@atosausa.com)  
www.atosa.com | www.atosausa.com  
California, Colorado, Florida, Georgia, Illinois,  
Massachusetts, New Jersey, Ohio, Texas, Washington

# Countertop Heated Display Cases - Curved / Square

**MODELS:**  
CHDC-44 / CHDC-56 / CHDS-53 / CHDS-71

## Standard Features

- Stainless steel exterior & interior
- Removable water pan to add humidity
- Electronic digital controller
- Three(3) stainless steel shelves standard
- Maintains temperatures between 86°F – 194°F
- Magnetic door gasket(s) standard for positive door seal
- Two(2) rear sliding glass doors
- LED interior lighting
- Leveling legs
- NEMA 5-15 plug with 5' cord



**CHDC-44**



**CHDC-56**

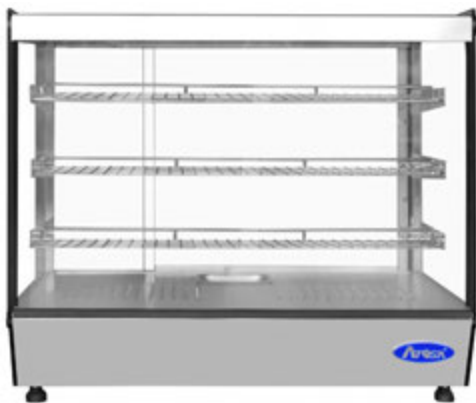

**CHDS-53**

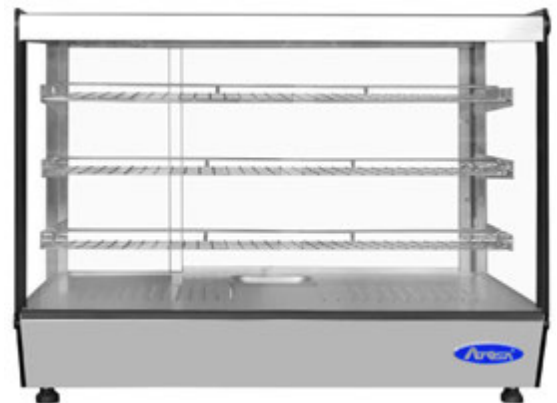

**CHDS-71**





**“WE MAKE THE KITCHEN BETTER!”**

Toll Free: 855-855-0399 Email: [info@atosausa.com](mailto:info@atosausa.com)  
[www.atosa.com](http://www.atosa.com) | [www.atosausa.com](http://www.atosausa.com)  
 California, Colorado, Florida, Georgia, Illinois,  
 Massachusetts, New Jersey, Ohio, Texas, Washington

## SPECIFICATIONS

Models	Door	Capacity (Cu.Ft.)	Shelves	Leveling Legs (Inch)	Rated Current (A)	Voltage (V/Hz/Ph)	Power (W)	Exterior Dimensions W×D×H(Inch)	Net Weight (lbs)	Gross Weight (lbs)
CHDC-44	2	4.4	3	1.5	10.5	115/60/1	1250	27 <sup>3/5</sup> ×22 <sup>1/10</sup> ×26 <sup>2/5</sup>	95	128
CHDC-56	2	5.7	3	1.5	13.7	115/60/1	1650	35 <sup>2/5</sup> ×22 <sup>1/10</sup> ×26 <sup>2/5</sup>	108	154
CHDS-53	2	5.3	3	1.5	10.5	115/60/1	1250	27 <sup>3/5</sup> ×22 <sup>1/10</sup> ×26 <sup>2/5</sup>	101	135
CHDS-71	2	3	1.5	13.7	115/60/1	1650	35 <sup>2/5</sup> ×22 <sup>1/10</sup> ×26 <sup>2/5</sup>	121	168	

## PLAN VIEW

**CHDC-44**

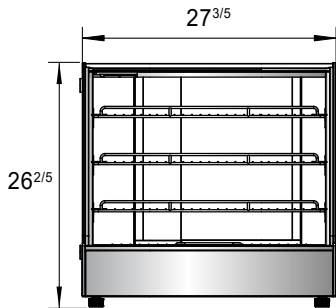

**CHDC-56**

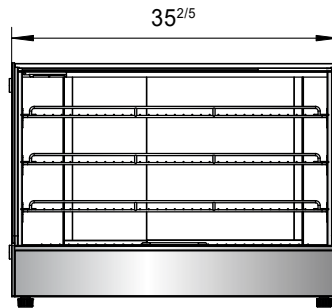

22<sup>1/10</sup>

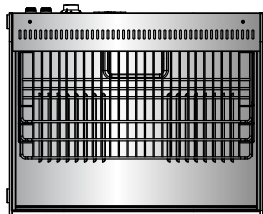
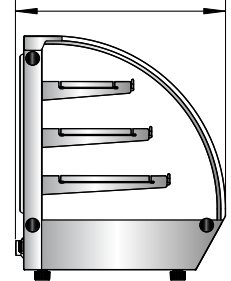

**CHDS-53**

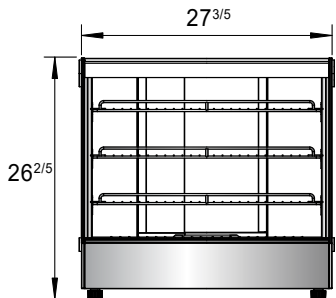

**CHDS-71**

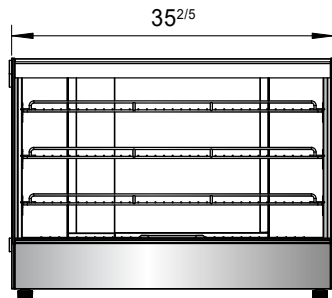

22<sup>1/10</sup>

