



“WE MAKE THE KITCHEN BETTER!”

Toll Free: 855-855-0399 Email: info@atosausa.com
www.atosa.com | www.atosausa.com
California, Colorado, Florida, Georgia, Illinois,
Massachusetts, New Jersey, Ohio, Texas, Washington

Countertop Heated Display Cases - Curved / Square

MODELS:
CHDC-44 / CHDC-56 / CHDS-53 / CHDS-71

Standard Features

- Stainless steel exterior & interior
- Removable water pan to add humidity
- Electronic digital controller
- Three(3) stainless steel shelves standard
- Maintains temperatures between 86°F – 194°F
- Magnetic door gasket(s) standard for positive door seal
- Two(2) rear sliding glass doors
- LED interior lighting
- Leveling legs
- NEMA 5-15 plug with 5' cord



CHDC-44



CHDC-56

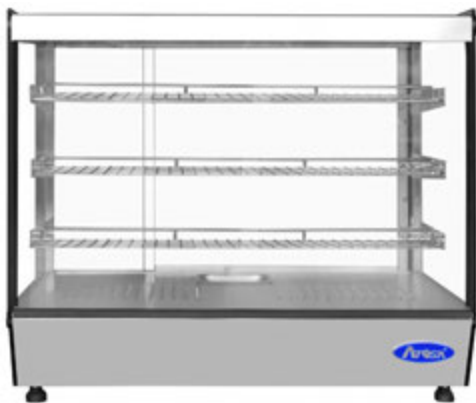

CHDS-53

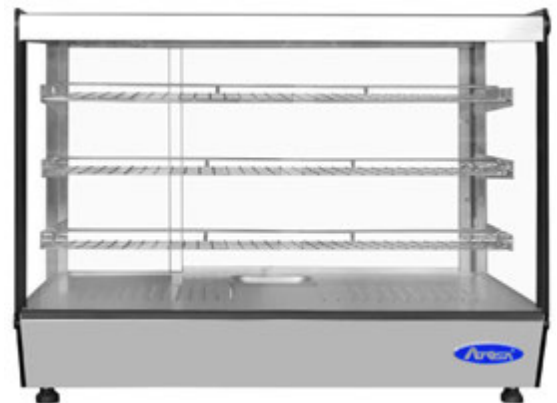

CHDS-71





“WE MAKE THE KITCHEN BETTER!”

Toll Free: 855-855-0399 Email: info@atosausa.com
 www.atosa.com | www.atosausa.com
 California, Colorado, Florida, Georgia, Illinois,
 Massachusetts, New Jersey, Ohio, Texas, Washington

SPECIFICATIONS

Models	Door	Capacity (Cu.Ft.)	Shelves	Leveling Legs (Inch)	Rated Current (A)	Voltage (V/Hz/Ph)	Power (W)	Exterior Dimensions W×D×H(Inch)	Net Weight (lbs)	Gross Weight (lbs)
CHDC-44	2	4.4	3	1.5	10.5	115/60/1	1250	27 ^{3/5} ×22 ^{1/10} ×26 ^{2/5}	95	128
CHDC-56	2	5.7	3	1.5	13.7	115/60/1	1650	35 ^{2/5} ×22 ^{1/10} ×26 ^{2/5}	108	154
CHDS-53	2	5.3	3	1.5	10.5	115/60/1	1250	27 ^{3/5} ×22 ^{1/10} ×26 ^{2/5}	101	135
CHDS-71	2	7.1	3	1.5	13.7	115/60/1	1650	35 ^{2/5} ×22 ^{1/10} ×26 ^{2/5}	121	168

PLAN VIEW

CHDC-44

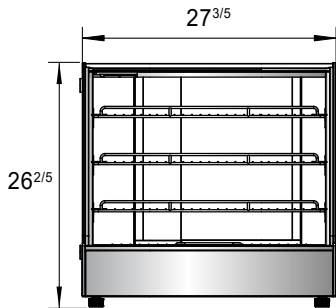

CHDC-56

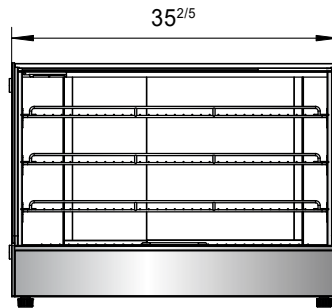

22^{1/10}

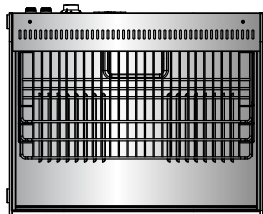
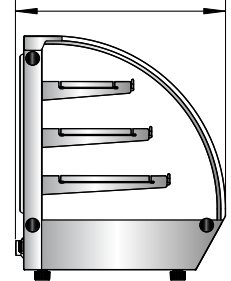

CHDS-53

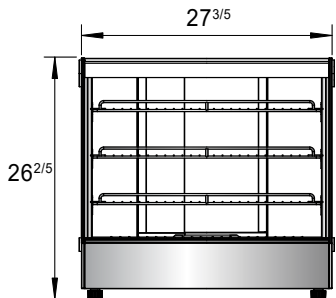

CHDS-71

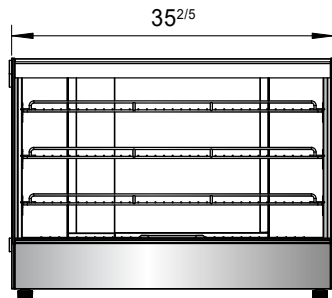

22^{1/10}

